

**VANDAL RESISTANT
BACK-LIT WEATHERPROOF
RFID ACCESS CONTROL KEYPAD**

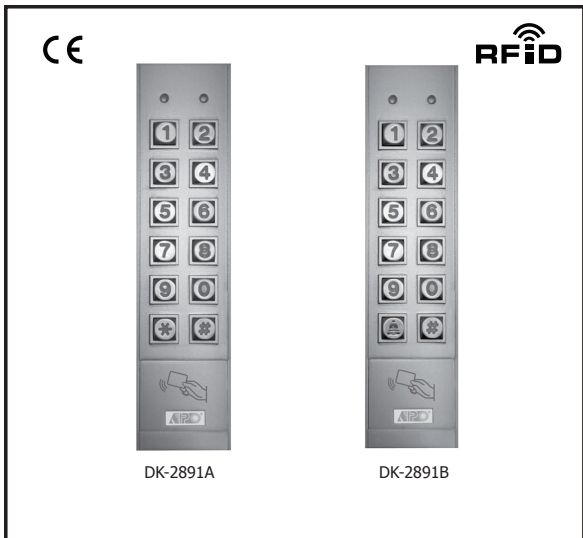

DK-2891A

DK-2891B

**DK-2891
User Manual (MK-II)**

**FOR ELECTRIC LOCK
AND SECURITY SYSTEMS**

TABLE OF CONTENTS

INTRODUCTION	4
FEATURES	4
OPTIONAL DEVICES FOR SYSTEM EXPANSION	5
SPECIFICATIONS	6
INSTALLATION	7
Precautions	7
CONNECTION TERMINALS AND INDICATORS	8-9
The On-Board LED Indicators	9
Pacifier Tone & The LED Signals	9
PREPARATION FOR PROGRAMMING	10-11
A) Criteria for Codes and Cards	10
B) Security Level of The Operation Media	10-11
C) List of User Information	11
PROGRAMMING AND OPERATION	12-36
Power Up The Keypad	12
Set Keypad into Programming Mode with Master Code	12
Direct Access to Programming Mode with The "DAP" Code – 2 8 2 8	13
System Refreshing with "Refreshing Code" --- 9 9 9 9	13
The Default Values after Refreshing	14
Master Code	15
Super User Code	15
Operation and Functions of The Super User Code.....	16-17
Common User Codes for Output 1 & 2	18
User Codes/Card For Output 1 & 2	19
Examples – Programming And Operation	20-22
Visitor Codes (For Output 1 Only)	23-24
Output Mode & Timing for Output 1 & 2	25
System Real-Time-Clock	26
Start & Stop Times For Daily Inhibition of Output 1	27-28
Personal Safety And System Lock-Out	29
User Code Entry Mode - Auto or Manual	30
Pacifier Tones On-Off Selection	30
Output Operation Announcer	31
Status LED Flashing On-Off during Standby	31
Intelligent Egress Button – An Unique Feature of A Contemporary Keypad	32-33
Where And Why "Going Out" Needs Attention	32-33
Egress Delay , Warning And Alarm	34-35

Operation Modes	36
Close The Programming Mode	36
PROGRAMMING MAKE SIMPLE - For General Users	37-38
PROGRAMMING SUMMARY CHART	39-40
APPLICATION EXAMPLES	41
Stand Alone Door Lock	41
Basic Wirings of a Stand Alone Lock	41
APPLICATION EXPANSIONS	42-47
The Axiliary Readers & Keypad	42
The Split-decoders	43
1) Dual-station Access Control Door Lock	44
2) Multi-station Access Control Door Lock	45
3) Split-decoded Access Control Door Lock	46
4) Split-decoded Multi-station Access Control Door Lock	47
APPLICATION HINTS FOR THE AUXILIARY TERMINALS	48-49
AUXILIARY INFORMATION	50

INTRODUCTION

DK-2891 is a self-contained two output relay, vandal resistant and weatherproof keypad. It combines the digital keypad and proximity EM card reader in one unit.

The keypad has been designed for stand alone access control applications. It is expandable to work with an optional decoder (DA-2800 or DA-2801) for high security split-decoded operation. It is also compatible with the auxiliary card reader (AR-2802) and the auxiliary keypad readers (AR-2806, AR-2807 and AR-2809) for upgrading a stand alone or split-decoded system to multi-station operation.

The keypad is ideally for door strike and alarm arm-disarm controls. It is also a programmable industrial timer (from 1 second to over 24 hours) for automatic operator system.

The DK-2891 has two versions. Version A comes with the Output Relay contacts 1 and 2 for door strike and auxiliary control respectively. The Version B comes with Output 1 for door strike and Output 2 for door bell activation.

DK-2891A – Output Relay 1 & 2 Controlled by User Codes / Cards

DK-2891B – Output Relay 1 Controlled by User Codes / Cards; Output 2 by Bell Button

FEATURES

- A member of the Tri-Tech series keypads compatible with the optional controllers & reader keypads for system expansion
- Loaded with the 2nd generation DK-2800 MK-II operation software
- Bi-directional Data I/O port compatible with all the optional devices
- Built-in with all the logics for stand alone, split-decoded and multi-station operations
- Controls "Going in" with User Codes / Cards and "Going out" with feature programmable egress button
- Independent control for the three output relays with programming timer
- Total 1,100 User Codes / Cards for controlling of the two outputs
- Indoor or outdoor installation with IP-65 all weather ingress protection
- Die-casting metal back-lit key buttons
- Vandal resistant die-casting housing

Package Contents

- One DK-2891 Keypad
- Two EM Cards
- One Pack of Mounting Screws
- One Hex Socket Screw Wrench
- One Programming & Installation Manual
- One Connection Harness

OPTIONAL DEVICES FOR SYSTEM EXPANSION

The Optional Decoders Available for Split-decoded Operation

DA-2800 – Full Feature Decoder with RF Remote Control

DA-2801 – Full Feature Decoder

The Auxiliary Reader / Keypad Available for Multi-station Operation

AR-2802S or A – EM Card Reader

AR-2806S or A – EM Card Reader with Digital Keypad

AR-2807S or A -- EM Card Reader with Digital Keypad

AR-2809S -- EM Card Reader with Digital Keypad

Remark:

The suffix letter "S" stands for standard version and "A" stands for advanced version. The advanced version possesses the standard features and also provides Wiegand and RS-232 data outputs for the custom projects with external controller and PC.

Please contact your local agent for the optional devices.

SPECIFICATIONS

- **Operating Voltage:**
12V DC Nominal; 11-15V DC
- **Operating Current:**
60mA (quiescent) to 100mA
- **Operation Temperature:**
-20°C to +70°C
- **Environmental Humidity:**
5-95% relative humidity non-condensing
- **Working Environment & Ingress Protection:**
Indoor or Outdoor, IP-65 Weatherproof
- **Number of Users:**
Output 1 - 1,000 (PINs and/or Cards)
Output 2 (Version A Only) - 100 (PINs and/or Cards)
- **Proximity Card:**
Standard EM Card or Keyfob, 125Khz
- **Number of Visitor Codes:**
50, programmable for one time or with the time limit
- **Timings for Code Entry and Card Reading:**
10 seconds waiting for next digit entry
30 seconds waiting for code entry after card reading
- **The Timer:**
1-99,999 Seconds (Over 24 Hours possible) Programmable Timer for O/P 1
- **Egress Button:**
Programmable for Instant, Delay with Warning and/or Alarm
Momentary or Holding Contact for the Exit Delay
- **Output Contact Ratings:**
Output Relay 1 – N.C. & N.O. Dry contacts, 2A/24VDC Max.
Output Relay 2 (or Door Bell) – N.O. & N.C. Dry contacts, 1A/24VDC Max.
Tamper Switch – N.C. dry contact, 50mA/24VDC Max.
- **Dimensions:**
179.7(H) X 46(W) X 21/25(D)mm
- **Weight:**
476g net
- **Housing:**
Zinc Alloy Die Casting Housing

Specifications are subject to change for modification without notice

ASSEMBLY

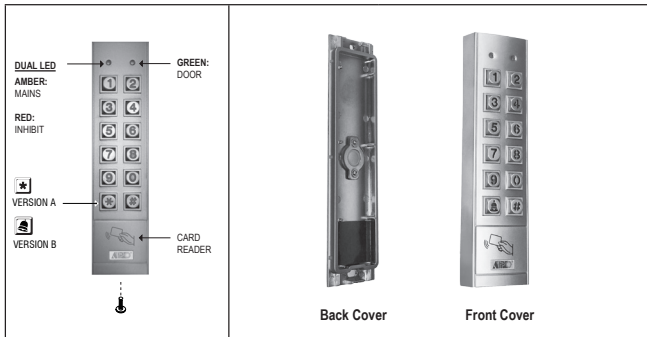

PRECAUTIONS

1) Prevent Interference:

The EM Card reader is working at the frequency of 125Khz. Installation precautions are necessary.

- i) Make sure the location for installation has no strong low frequency electro-magnetic wave. Especially in the range of 100-200Khz
- ii) If there is more than one keypads with the same operation frequency installed closely in the location, make sure that they are at least 60cm (2ft) apart from each other to prevention interference.

2) Prevent Accidental Short Circuit:

In the previous experience, most of the damages caused in the installation are accidental touching of the components on circuit board with the wires carrying power. Please be patient to study the manual to become familiar with the specifications of the system before starting the installations.

- i) Do not apply power to the system while it is in installation.
- ii) Check carefully all the wirings are correct before applying power to the system for testing.

CONNECTION TERMINALS AND INDICATORS

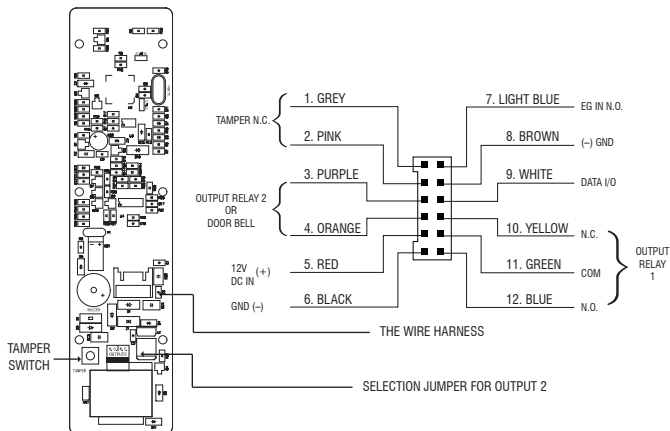

1 - 2 : TAMPER N.C. (Tamper Switch Normally Closed Contact)

A normally closed dry contact while the front cover is secured on the main box. It is open while the cover is separated from the box. Connect this N.C. terminal to the 24 hour protection zone of an alarm system if necessary.

3 - 4 : OUTPUT 2 (Version A) OR DOOR BELL (Version B)

A relay output dry contact with maximum rating of 24 VDC/1Amp which is selectable for N.C. (Normally Closed) or N.O. (Normally Open) output via jumper.

DK-2891A - Output contact controlled by the PINS and/or cards in group 2

DK-2891B - Output contact controlled by the Bell Button

SELECTION JUMPER FOR OUTPUT 2

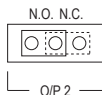

OUTPUT 2

5 - 6 : 12V DC (Power Input Terminal)

Connect to 12V DC power supply. The (-) GND is the common grounding points of the system.

7 : EG IN (Egress Input)

A Normally Open (N.O.) input terminal referring to (-) ground. With the help of connecting a normally opened button to activate the Output 1 for electric door lock strike in the same manner of using the Group 1 User PINs or Cards.

Egress button is usually put inside the house near the door. More than one egress buttons can be connected in parallel to this terminal. Leave this terminal open if not used.

See Programming Location 90 for more information about the Egress Button with other features.

8 : GND (-) (Common Ground)

A common grounding point of the keypad, it is common to the Black wire, terminal 6.

9 : DATA I/O (Data Input/Output Port for Split-Decoded Operation)

A data bus for signal communication with the optional Access Controller in Split-decoded operation and Auxiliary Reader-keypad in multi-station operation.

10 - 11 - 12 : OUTPUT 1 (Output Relay 1)

2 Amp relay dry contact controlled by the Group 1 user PINs or Cards for Output 1, recommended for door strike. Terminal 10 is Normally Closed (N.C.), terminal 12 is Normally Open (N.O.) and terminal 11 is the common point of the two contacts. Use N.C. output for Fail-safe locking device; and N.O. output for Fail-secure locking device. The relay is programmable for Start/Stop (toggle) mode or Momentary timing mode. See programming Location 51 for the details.

THE ON-BOARD LED INDICATORS

MAINS (AMBER) ----- It flashes in Standby. It shows the system status in synchronization with the beep tones. The standby flashing can be set to OFF in programming. See Location 73 for the details.

INHIBIT (RED) ----- It is a system inhibited indicator. It lights up while the output 1 is locked-up.

DOOR (GREEN) ----- It lights up for Output 1 activation.

PACIFIER TONES & THE LED SIGNALS

The buzzer and the amber LED indicator give following tones and signals respectively for system status:

STATUS	TONES *	AMBER LED
1) In Programming Mode	-----	ON
2) Successful Key Entry	1 Beep	1 Flash
3) Successful Code / Card Entry	2 Beeps	2 Flashes
4) Unsuccessful Code / Card Entry	5 Beeps	5 Flashes
5) Power Up Delay	Continuous Beeps	Continuous Flashes
6) Output Relay Activation **	1 Second Long Beep	-----
7) In Standby ***	-----	1 Flash in 1 Second Interval
8) System Refreshing	-----	Fast Flashes for 2.5 Minutes
9) Card or Code Already Stored in System	1 Long Beep	-----
10) Keypad link-up with Decoder Failed	Continuous 1 Beep/5 secs	-----
11) Real-time-clock stopped after power failure	Continuous 3 Fast Beeps /5 secs	-----

NOTE:

* All Pacifier Tones can be ON or OFF through the programming option at Location 71

** The Output Relay Activation beep can be selected through the programming option at Location 72

*** The Standby flashing can be ON or OFF through the programming option at Location 73

A) CRITERIA FOR CODES AND CARDS

1) *Prime Codes*

The prime codes include the a) User Codes, b) Master Code, c) Duress Codes, d) Super User Codes, e) Common User Codes and f) Visitor Codes. All these codes **MUST** be unique. It is not allowed to repeat a prime code for second function.

All the codes in this system can be 4-8 digits for Manual Entry Mode. The codes must be in the same digit length with the Master Codes for Auto Entry Mode. See Location 70 for the details.

2) *Prime Cards*

All the User Cards are prime cards. They are not allowed to program for second function. e.g. a card was programmed for operating output 1 is not allowed for output 2.

The cards used in this system are 125Khz proximity EM cards.

3) *Secondary User Codes*

A Secondary User Code is prepared to enhance the security of an user card, which is a code put after a card. The keypad requires both card and code are correct to grant an entry. The secondary code can be repeatedly used for a group of cards; or proprietary with one code for one card.

NOTE:

The keypad will reject repeated use of prime card or prime code in programming and give one long beep indication.

B) SECURITY LEVEL OF THE OPERATION MEDIA

The keypad provides 5 operation Media for owner's selection of security level. See programming Location 10 & 20

1) *EM Card Only – Operation Media 1*

A general way for access control, just simply read a card to open the door. Security level is moderate but it is user convenient.

2) *User Code Only – Operation Media 2*

A general way for access control, just simply enter a code to open the door. Security level is moderate but it is user convenient.

3) *EM Card + Common User Code – Operation Media 4*

The keypad requires both Card and Common User Code are correct to grant an entry. Common User Code is an user code for all the cards. Two media are used in door control. The security level is better than just card or user code alone.

This operation mode can also report Duress Alarm by keying the duress code instead of common user code in emergency when the user is forced to open the door.

4) *EM Card + Group Secondary User Code – Operation Media 3*

A secondary user code can be repeatedly used for a group of cards in a department. Owner can make a proprietary department code for each department in a company. Only the staff of the department holding a card and knowing the code is accepted to enter. This approach increases the departmental security and prevents a lost card picked up by other group of people in the company to open the door.

This operation mode can also report Duress Alarm by keying the duress code instead of common user code in emergency when the user is forced to open the door.

5) EM Card + Proprietary Secondary User Code – Operation Media 3

The keypad accepts programming with each card having its own proprietary user code to work. It prevents any other people can use the lost card to open the door. Card with proprietary user code approach is ideal for the area that high security is the main concern.

This operation mode can also report Duress Alarm by keying in the duress code instead of Secondary user code in emergency when the user is forced to open the door.

C) LIST OF USER INFORMATION

The keypad can accommodate up to 1,100 users (codes / cards). To avoid confusion and for programming convenience, it is suggested to make a list recording of the user information. It helps the owner to program the user codes and cards smoothly and to trace them afterwards in the future. Here is a suggested format of the list.

List of Users (See page 19-22 for reference)

Example:

User	Name	Location	Media	User ID	Code	Card #	Remark
1	John	10	1	001	/	001	Output 1
2	May	20	2	001	1234	/	Output 2
3	Tom	10	3	002	24680	002	Output 1
4	Tracy	10	4	003	Common	003	Output 1
5							
6							
7							
8							
9							
10							
11							
12							
13							
14							
15							
16							
--							
1,000							

POWER-UP THE KEYPAD

The keypad gives power-up delay of 1 minute after power has been applied. It is the time frame designed for setting the keypad to programming mode with DAP code. See the details of “**DAP CODE – 2 8 2 8**” below.

- 1) The keypad gives continuous beeps for 1 minute after power-up.
- 2) The power-up delay can be stopped instantly with **1 2 #** if the delay beep is found annoying and setting the keypad to programming mode with DAP code is not required.

POWER-UP DELAY STOP

1 2



VALIDATION

#

- 3) The keypad will set itself to Normal Operation Mode automatically after the 1 minute power-up delay expired or it is stopped with **1 2 #**.

SET KEYPAD IN PROGRAMMING MODE WITH MASTER CODE

It is always necessary to set the keypad in programming mode for feature programming

The keypad is in normal operation after power-up delay. Set it in programming mode with Master Code and validate it with *** *** or **🔔 🔔**.

MASTER CODE

0 0 0 0



VALIDATION

*** ***

NOTE:

- a) For those keypads with door bell button, the **🔔** button is equivalent to the ***** button.
- b) For the owner’s convenience in programming at the first time, a Master Code **0 0 0 0** has been put into the keypad before exit-factory. It is **NOT** a default code. For security reason, owner should program a personal Master Code to replace it after the keypad is owned.
- c) The Mains LED (amber) is ON after the keypad confirms it in programming mode with 2 beeps.
- d) **DO NOT** turn off power while the keypad is in programming mode. Otherwise, it may cause error to the data in memory.

DIRECT ACCESS TO PROGRAMMING MODE WITH “DAP” CODE -- 2 8 2 8

In case the Master Code is forgotten, apply the following procedures precisely to set keypad into programming mode with DAP code:

- 1) Switch OFF all the power for 1 minute to ensure that the keypad is fully discharged.
- 2) Switch ON power again. The keypad is in Power-up Mode for 1 minute. The buzzer gives continuous beeps and the Status LED is flashing. This is the only time frame to accept the DAP code.
- 3) Press the Egress Button (the button connecting across EG IN, (Terminal 7) and (-)GND, (Terminal 8) once to enable the keypad for accepting DAP code. The power-up beep stops after the Egress Button is pressed.
- 4) Key in the DAP code and validate it with (or). The Status LED is ON and the keypad is in programming mode like using Master Code. It is ready to accept new programming data as long as you like until exit programming mode.

EGRESS BUTTON



DAP CODE



VALIDATION

- 5) To program a new Master Code to replace the old one. See “**Record A Master Code**” stated at “Location 01” for the details.

NOTE:

The keypad will set itself to normal operation mode 1 minute after power-up if the Egress Button is not pressed and the DAP code is not keyed in. To set keypad back to power-up mode, repeat procedures 1-4.

SYSTEM REFRESHING WITH “REFRESHING CODE” --- 9 9 9 9

The keypad can be refreshed by cleaning all the programmed old data and set it back to default values except the Master Code.

REFRESHING CODE



VALIDATION

NOTE:

- a) Make sure that system refreshing is really required before entering the refreshing code.
- b) Refreshing takes few minutes. The status LED (amber) keeps flashing during refreshing.
- c) The keypad is back to its default value after refreshing. Re-program of the desired values are necessary.

THE DEFAULT VALUES AFTER REFRESHING

LOCATION	PARAMETERS	DEFAULT FUNCTIONS & VALUES
0 1	Master Code	0 0 0 0 Factory Set, Not a default value *
0 2	Super User Codes	Nil ----- User Program Required
0 3	Common User Code 1	Nil ----- User Program Required
0 4	Common User Code 2	Nil ----- User Program Required (DK-2891A only)
1 0	User Codes & Cards for O/P 1	Nil ----- User Program Required
2 0	User Codes & Cards for O/P 2	Nil ----- User Program Required (DK-2891A only)
4 0	Visitor Codes	Nil ----- User Program Required
5 1	O/P Mode of The O/P 1	Time = 5 Sec, Momentary
5 2	O/P Mode of The O/P 2	Time = 5 Sec, Momentary (DK-2891A only)
5 5	System Real-Time-Clock	Nil ----- User Program Required
5 6	Start & Stop Time	Nil ----- User Program Required
6 0	Personal Safety & Lock-out	Code = 1, 10 False Code/Card Lock-out 60 Sec
7 0	User Code Entry Mode	Code = 2, Manual Entry Mode
7 1	Pacifier Tones ON-OFF Selection	Code = 1, Pacifier Tone ON
7 2	O/P Operation Announcer	Code = 1 Sec, Notification Beep ON
7 3	Status LED Standby Flashing ON-OFF	Code = 1, Flashing Enabled
9 0	Egress Delay & Warning	Code 1 = 0, Instant, No Delay
		Code 2 = 1, Momentary Contact without Warning
9 4	Operation Modes	Code = 0, Keypad Mode

NOTE:

The DAP Code **2 8 2 8** and the Refreshing Code **9 9 9 9** are fixed in the operating system program. It can not be changed in any ways.

MASTER CODE**(Location 01)**LOCATION

0 1

(1)

MASTER CODE

4 to 8 Digits

(2)

VALIDATION

#

(3)

(1) LOCATION

- Key in Location 0 1

(2) MASTER CODE

- Master Code is the authorization code for setting the system to programming mode. It is **NOT** an User Code operating the output relays.
- The Master Code can be 4 to 8 digits.
- When a new master code is keyed in and confirmed, the old master code is replaced.
- The master code is also the **Link-up Code** between the keypad and the optional decoder in Split-decoded operation.

(3) VALIDATION

- Press # key once. Two-beep confirms the entry.

Example:

Set a Master Code "2 2 3 3" ---- 0 1 2 2 3 3 #

SUPER USER CODE**(Location 02)**

The Super User Code has TWO functions. It is prepared to operate the two outputs and make operation of inhibit enable / disable to those outputs.

LOCATION

0 2

(1)

SUPER USER CODE

4 to 8 Digits

(2)

VALIDATION

#

(3)

(1) LOCATION

- Key in Location 0 2

(2) SUPER USER CODE

- The Super User Code can be 4 to 8 digits.
- When a new Super User Code is keyed in and confirmed, the old one is replaced.

(3) VALIDATION

- Pressing # key to confirm code entry.

Example:

a) Set a Super User Code "2 5 8 0" ---- 0 2 2 5 8 0 #

b) Deleted a Super User Code from memory: Key in the Location number and #. ---- 0 2 #

OPERATION AND FUNCTIONS OF THE SUPER USER CODE

1) Operate Output 1 and 2

The operation of the Super User Code is just like a normal User Code. Simply key-in the Code with a specific output number for the desired Output. The Super User Code can also be used to reset an operating output timer instantly.

SUPER USER CODE # **1** ----- Output 1 Activates or Resets

SUPER USER CODE # **2** ----- Output 2 Activates or Resets

Optional Functions Controlled by Super User Code for Output 1

Apart from controlling of the three outputs 1 and 2; the Super User Code can also be used to enable the optional functions controlling **Output 1** for user convenience or security enhancement.

Super User Code and Egress Button are excluded from any system inhibition and lockup functions; they are valid for door open at anytime for safety.

2) Override The Door Lock Controlled by Output 1 (Keep Door Un-locked)

The Output 1 is usually for door lock control. In some situations, the door may require un-locked for a period of time to allow door opening without User Code or EM Card for entry / exit convenience. This function Starts / Stops in toggle with the following code entry.

SUPER USER CODE # **7** ----- The Door is Un-locked, Start / Stop in Toggle

NOTE :

- The door is un-locked while the function is enabled. The "Output 1" LED (Green) turns ON.
- **Do not** forget to stop this function after use because the door is un-locked. Also, the system refuses the optional functions (3) & (4) while Override function comes into effect.
- This feature is **good for all the "Fail-safe electric locks"**.
- "**Fail-secure electric lock**" requires power to keep in un-locked condition. It takes high current all the time while the function comes into effect and **may cause damage** to it. This function is not recommended for Fail-secure electric lock.

3) Pause The Scheduled Daily Inhibition for Output 1 (Temporarily Disable The Inhibition)

The scheduled inhibition can be programmed and applied to Output 1 with daily start and stop times. It can be stopped temporarily if required; such as the staff work overtime after office hours going into the inhibition period. This function Starts / Stops in toggle with the following code entry. It can be done before or during the inhibition period.

SUPER USER CODE # **8** ----- Door Lock Operation Resumes, Start / Stop in Toggle

NOTE :

- The "INHIBIT" LED (Red) is ON in inhibition and turns to Flashing while pause is into effect.
- See **Programming Locations 55 & 56** for more information Daily Inhibition.

4) Inhibit All The User Codes & EM Cards for Output 1 (Disable Access Control Manually)

To enhance the security of the access control keypad, the owner can stop the keypad after office hour or while the house is nobody inside. Once the Output 1 (for door lock control) is inhibited, all the User Codes / Cards for it become invalid and those people holding the User Code or Card are refused. This function Starts / Stops in toggle with the following code entry.

SUPER USER CODE



----- Door Lock Operation Inhibited, Start / Stop in Toggle

NOTE :

- The door is locked during Output 1 inhibited and the "INHIBIT" LED (Red) is ON.
- Inhibition applies to all User Codes and EM Cards for Output 1 only. Output 2 is not affected.

COMMON USER CODES FOR OUTPUT 1 & 2**(Locations 03 & 04)**

The Common User Codes 1 and 2 are prepared for operating Output 1 and 2 respectively as an enhance code. The Common User Codes **MUST** work in the form of "Card + Common Code" to operate the outputs to increase the security of the access control system. See Media 4 at Locations 10 & 20 for more information.

NOTE: Common User Code alone can **NOT** operate the Outputs directly.

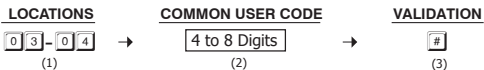
**(1) LOCATIONS**

- | | |
|---|---|
| 0 | 3 |
|---|---|

 -- Location Stores The Common User Code for Output 1
- | | |
|---|---|
| 0 | 4 |
|---|---|

 -- Location Stores The Common User Code for Output 2 (DK-2891A only)

(2) COMMON USER CODES

- The Common User Code can be 4 to 8 digits.
- When a new Common User Code is keyed in and confirmed, the old one is replaced.

(3) VALIDATION

- Pressing

#

 key to confirm code entry.

Example:

a) Set a Common User Code "1 3 5 7" for Output 1 ----

0	3
---	---

1	3	5	7
---	---	---	---

#

b) Deleted a Common User Code from memory: Key in the Location number and #. ----

0	3
---	---

#

Total 1,100 User Codes / Cards are available for controlling of the two outputs.

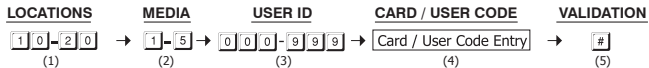

(1) LOCATIONS (User Groups)

- 1 0 – Group 1 – 1,000 User Codes / Cards for controlling Output 1
- 2 0 – Group 2 – 100 User Codes / Cards for controlling Output 2 (DK-2891A only)

(2) MEDIA (Operation Media)- please also see page 10 for more information of their security level

- 1 – Cards Only – 125Khz Proximity EM Card
 - 2 – User Codes Only – 4-8 Digits
 - 3 – Cards + Secondary User Code(s) – **See Note (a)**
 - 4 – Cards + Common User Code – **See Note (b)**
 - 5 – Delete Cards / User Codes from the selected User ID – **See Note (c)**
- 0 9 9 9 – Group Clearing. Clear all the User Codes & Cards of the selected User Group Location. Clearing takes few seconds to a minute.

(3) USER ID (The IDs of The User Codes and Cards)

- 0 0 0 – 9 9 9 – 1,000 User IDs for the User Codes & Cards in User Group 1 (Output 1)
- 0 0 1 – 1 0 0 – 100 User IDs for the User Codes & Cards in User Group 2 (Output 2)

(4) CARD / USER CODE

Read EM Card or **key in User Code** into each assigned User ID.

(5) VALIDATION

Press the # key once. Two-beep confirms the entry.

NOTE:

- (a) The Secondary User Code is a user code putting after a card in programming. It can be a proprietary user code for each user card or a code repeatedly used for a group of user cards as group user code (e.g. for a group of staff working in the same department).
- (b) The Common User Codes for the Output 1 and 2 have been programmed first at Locations 03 and 04 respectively. It is not necessary to key in the code again in programming here and it will follow the card automatically after the card is read.
- (c) Deletion of an User Code or Card (if the card was lost) can be done by keying-in its ID number. For deleting an existing cards, simply read the card once and confirm. It does not require the ID number. The Card includes the combinations of (1) Card Only, (2) Card + Secondary User Code and (3) Card + Common User Code.

EXAMPLES – PROGRAMMING AND OPERATION

1) Example 1 -- EM Card Only :

i) Programming :

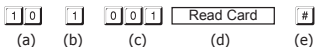

- (a) The card is programmed for operating Output 1
- (b) The operation is medium EM Card only
- (c) Take ID number 001 in Group 1 to store the card, which is one of the IDs in 000-999
- (d) Put the card close to the reader, one beep confirms the reading
- (e) Press # to store the "Card", two-beep confirms a valid entry

ii) Operation : (while the system is back to operation mode)

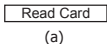

- (a) Read the EM card. Two-beep confirms the card is read and Output 1 activates

2) Example 2 -- Private User Code Only :

i) Programming :

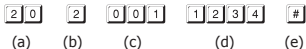

- (a) The Private User Code is programmed for operating Output 2
- (b) The operation medium is Private User Code only
- (c) Take ID number 001 in Group 2 to store the Private User Code, which is one of the IDs in 001-100
- (d) Put Private User Code "1 2 3 4" into the storage location
- (e) Press # to store the "Private User Code", two-beep confirms a valid entry

ii) Operation : (while the system is back to operation mode)



- (a) Key in the Private User Code "1 2 3 4"
- (b) Confirm it with the # key. Output 2 activates

3) Example 3 -- EM Card + Secondary User Code :

i) Programming :

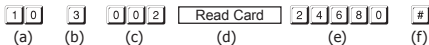

- The card is programmed for operating Output 1
- The operation medium is EM Card + Secondary User Code
- Take the ID number 002 in Group 1 to store the Card & Code, which is one of the IDs in 000-999
- Put the card close to the reader. One beep confirms the reading
- Put Secondary User Code "2 4 6 8 0" after reading of card
- Press # to store the "Card + Secondary User Code", two-beep confirms a valid entry

ii) Operation : (while the system is back to operation mode)



- Read the EM card. Two-beep confirms the reading and 30 seconds waiting time is given for entry of the User Code, the Amber LED keeps flashing
- Key in the Secondary User Code "2 4 6 8 0"
- Confirm it with the # key. Output 1 activates

4) Example 4 -- EM Card + Common User Code:

i) Programming :

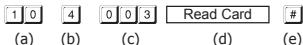

- The card is programmed for operating Output 1
- The operation medium is "EM Card + Common User Code"
- Take ID number 003 in Group 1 to store the card, which is one of the IDs in 000-999
- Read the EM card. One beep confirms the reading. (No need to key in a Common User Code but there MUST be a Common User Code already recorded in Location 03; (or 04 for O/P 2).
- Press # to store the "Card". Two-beep confirms a valid entry

ii) Operation : (while the system is back to operation mode)



- Read the EM card. Two-beep confirms the reading and 30 seconds waiting time is given for entry of the Common User Code, the Amber LED keeps flashing
- Key in the Common User Code "1 3 5 7" (the number programmed in "Location 03" for Output 1 in the previous Example)
- Confirm it with the # key. Output 1 activates

5) Example 5 -- Delete An User Code & / or EM Card (for O/P 1 or 2) :

i) Delete An User Code or A Lost EM Card

(a) (b) (c) (d)

- (a) Key in the User Group that the User ID belongs to. "10" for Group 1 and "20" for Group 2
- (b) Key in "5" that is the Command Code for making a deletion
- (c) Key in the User ID that stored the User Code, the lost EM card or the EM Card+User Code
- (d) Press the # key. Two-beep confirms a valid entry and the Code and/or Card in that User ID is cleared

ii) Delete an EM Card

(a) (b) (c) (d)

- (a) Key in the User Group that the EM Card belongs to. "1 0" for Group 1 and "2 0" for Group 2
- (b) Key in "5" that is the Command Code for making a deletion
- (c) Read the EM card. One-beep confirms the reading. Read the Card only also makes a valid deletion to the Card working with the Common User Code or the Secondary User Code
- (d) Press the # key. Two-beep confirms a valid entry. The EM Card in that User ID is cleared. Key in the User ID is not required.

6) Example 6 – Clear The Whole Group of Users :

Whole group of users including the Codes and Cards can be cleared with the following command.

(a) (b) (c)

- (a) The User Group 1 – "10" is selected to be cleared. "20" for Group 2
- (b) Key in the Group Deletion Command, 0 9 9 9
- (c) Confirm the deletion with #. All the User Codes and Cards in Group 1 are cleared. It takes few seconds to a minute to complete depending on the data stored.

The Visitor Codes are temporary user codes for Output 1 (mainly for door strike in access control). They can be programmed as “**One Time Codes**” or “**Codes with Time Limit**”. The Visitor Codes will be cleared automatically after use if they are one time codes, or, when the allowed time expires.

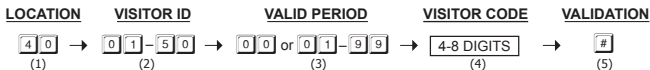
**(1) LOCATION**

Key in Location

(2) VISITOR ID

- --- 50 Visitor IDs for the 50 visitor codes. They are Two-digit numbers

= Clear all the Visitor Codes in Location 40. Please see the Programming example below for the details.

(3) VALID PERIOD

The codes in this box **MUST** be two digits and they represent the time of operation.

--- One Time Code

One Time Code has no time limit but it can only be used for ONCE. It is cleared by the system automatically after use.

- --- Time Limit in Hour(s)

The Visitor Code can be set with the valid time limit of 1 Hour to 99 Hours with a two-digit number of 01 to 99. The visitor code is cleared by the system when the time limit reaches.

(4) VISITOR CODES

- The Visitor Codes can be 4-8 digits for Manual Mode code entry.
- The Visitor Codes **MUST** be in the same digit length with the Master Code for Auto Mode code entry.
- When a new Visitor Code is put in the same Code box, the old code is replaced.

NOTE: All Visitor Codes will be cleared after power down to prevent extension/confusion of their valid time limit.

(5) VALIDATION

Press key once. Two-beep confirms the entry.

EXAMPLES:

Example 1: Set a "One Time Visitor Code" with the number of "1 2 6 8" for the Output 1

(a) (b) (c) (d) (e)

(a) Visitor Code Programming, (b) The Visitor ID, (c) An One Time Code, (d) The Visitor Code, (e) Entry Confirmation

Example 2: Set a "Visitor Code" with the number of "1 3 7 8" that is valid for three hours

(a) (b) (c) (d) (e)

(a) Visitor Code Programming, (b) The Visitor ID, (c) Valid for 3 Hours, (d) The Visitor Code, (e) Entry Confirmation

Example 3: Delete a "Visitor Code" from Visitor ID 02 in the memory

(a) (b) (c)

(a) Visitor Code Programming, (b) The Visitor ID, (c) Delete Confirmation

Example 4: Clear all "Visitor Codes" in Location 40

(a) (b) (c)

(a) Visitor Code Location, (b) The Deletion Command Code, (c) Confirmation, all Visitor Codes are cleared

OUTPUT MODE & TIMING FOR OUTPUT 1 & 2

(Locations 51 & 52)

The two relay outputs are programmable for Start/Stop or Timing modes. Apart from door access control, alarm arm-disarm control, they are also **universal timers for automatic operators in industry** with their 99,999 seconds (over 24 hours) programmable timer.

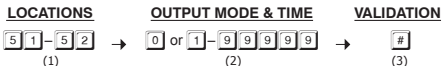

(1) LOCATIONS

5 1 -- Location for Output 1

5 2 -- Location for Output 2 (DK-2891A only)

(2) OUTPUT MODE & TIMING

0 - Start /Stop Mode (Toggle)

The number 0 sets the output to **Start / Stop mode**. The output **Starts** when an User Code and/or Card is entered/read; the output **Stops** when an User Code and/or Card is entered/read again.

1 - 9 9 9 9 9 9 -- Seconds Momentary --- (Default -- Momentary 5 Seconds)

The output can be set in **Momentary Mode** with the time of 1 second to 99,999 seconds. The output will reset automatically when the time expires.

(3) VALIDATION

Press # key once. Two-beep confirms the entry.

RESET OUTPUT TIMER WITH SUPER USER CODE

The Output Timer can be **RESET manually at anytime with the Super User Code** that operates the desired output before the end of the time.

Example:

Reset Output 1 Timer -- SUPER USER CODE # 1 ----- Output 1 stops

Reset Output 2 Timer -- SUPER USER CODE # 2 ----- Output 2 stops

SYSTEM REAL-TIME-CLOCK**(Location 55)**

This 24 hour real-time-clock provides the daily time base for starting and stopping the function of inhibition to relay output 1 (mainly for electric door lock strike).

No real-time-clock setting is required if daily start-stop inhibition at Location 56 is not enabled.

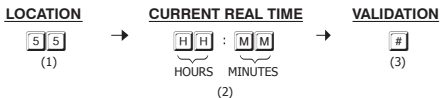
**(1) LOCATION**

Key in Location

5

5

(2) CURRENT REAL TIME

H

H

 :

M

M

 – The current time in Hour and Minute. The allowed time figure is **00:00 – 23:59**

The time setting is based on 24 hours daily with the first two digits for hours and the last two digits for minutes. The time in second always starts at 0 0.

(3) VALIDATION

Press

#

 key once.

Two-beep confirms the setting and the clock starts to count in 24 hour basis from the programmed current time.

Programming Examples:

a) Set the current time of "10:30" (AM) to the keypad ----

5

5

1

0

3

0

#

b) Set the current time of "6:45" (PM) to the keypad -----

5

5

1

8

4

5

#

IMPORTANT NOTE:

- 1) The real-time-clock stops after power failure, which makes the real-time inhibition loses its time base. **It is necessary to re-program the system's real-time-clock** unless the keypad is back up with UPS.
- 2) The keypad gives **warning beeps of 3 fast beeps / 5 seconds continuously after power failure** until the real-time-clock is re-programmed.
- 3) No "after power failure warning beep" will be given if **Location 56** is not programmed with Start/Stop times.
- 4) Suggest to program the clock every 3-6 months to keep time accuracy; or when time deviation is found.

START & STOP TIMES FOR DAILY INHIBITION OF OUTPUT 1**(Location 56)**

Setting with start and stop times into the keypad, the real-time inhibition period for output 1 will recycle daily until the time settings are cleared.

This function works with the real-time-clock. Set up the real-time at Location 55 is necessary.

For safety reason, the Egress Button is designed always valid. The door lock (controlled by output 1) can be opened with it at anytime during inhibition.

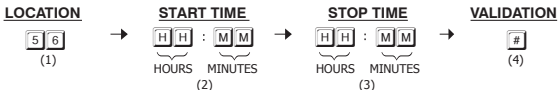
**(1) LOCATION**

Key in Location **5 6**

(2) START TIME

H H : M M – Set the real-time inhibition starting time in Hour and Minute. The allowed time figure is **00:00 – 23:59**

The starting time is based on 24 hours daily with the first two digits for hours and the last two digits for minutes. The time in second always starts at 0 0.

(3) STOP TIME

H H : M M – Set the real-time inhibition stopping time in Hour and Minute. The allowed time figure is **00:00 – 23:59**

The stopping time is based on 24 hours daily with the first two digits for hours and the last two digits for minutes. The time in second always starts at 0 0.

(4) VALIDATION

Press **#** key once.

Two-beep confirms the setting.

Programming and Operation Examples:

(i) Set the starting and stopping time for the real-time inhibition period

a) Set Inhibition Period from 12:30 PM (today) – 1:30 PM (same day) for lunch time:

b) Set Inhibition Period from 6:30 PM (today) – 8:15 AM (next day) for office close:

NOTE:

- 1) The start and stop time figures are 24 hours basis. They are 4-digit figures from the smallest **00:00** to the largest **23:59**.
- 2) Entry of the two figure values from **Small (Start) to Large (Stop)** for the period of inhibition; the inhibition will start and stop in the same day. See **example (a)**.
- 3) Entry of the two figure values from **Large (Start) to Small (Stop)** for the period of inhibition; the inhibition will start at the time of the day; thus stop in the next day. See **example (b)**.
- 4) The keypad does not accept the "Start" and "Stop" times with same value. The two time figures must be different.

(ii) Clear the function of inhibition

Clear the time settings to stop the function of inhibition:

(iii) Pause the real-time inhibition manually

The real-time inhibition can be stopped temporarily if require; such as the staff work overtime in office. The inhibition can be paused manually with Super User Code before or during the inhibition period. The pause is toggle and does not affect the real time period counting.

---- Inhibition paused [Inhibit LED(Red) Flashing]

---- Inhibition resumes [Inhibit LED(Red) ON]

NOTE:

The "INHIBIT" LED(Red) is flashing during the paused period; and it is ON after inhibition resumes.

(iv) Open door lock with Super User Code at anytime

The Super User code is valid all the time even in the inhibition period. This function does not affect the real time period counting.

---- The door is open

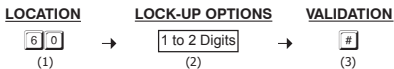
**(1) LOCATION**

Key in Location

6

0

(2) LOCK-UP OPTIONS

The Options are represented by the following Numbers. They are described below:

1

 --- After 10 successive false Card/User Code trials, the keypad locks during 60 seconds.
- (Default)

5

 -

1

0

 --- Selection of after 5 to 10 successive Card/User Code trials, the keypad locks during 15 minutes. The keypad can be reset to release the lock-up with the "Super User Code" in the following way.

Example: Release the lock-up --

SUPER USER CODE

#

9

0

0

 --- Disappearance of all the above lock-up securities.

(3) VALIDATION

Press

#

 key once. Two-beep confirms the entry

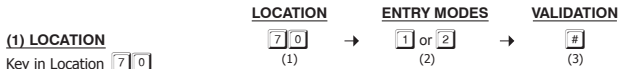
**(2) USER CODE ENTRY MODES**

Two modes 1 and 2 are available for User Code entry options. The **EM Card is always in Auto Entry Mode** and is not affected by the selection here.

[1] --- Auto Entry Mode

Auto Entry Mode requires no pressing of the # key after code entry for code checking.

In the Auto Entry Mode, the **User Codes MUST be set in the same digit length of the Master Code** (For example, if the Master Code is 5 digits, then all User Codes must be in 5 digits as well. All other User Codes not in 5 digits become invalid). When the number of digits reaches, the system will check the User Code automatically. Good for high traffic access control.

[2] --- Manual Entry Mode – (Default)

Manual Entry Mode always requires the # key following the User Code for code checking. The User Codes can be **4-8 digits arbitrary** and they are **NOT** required to be in the same digit length of the Master Code. Manual Entry increases the level of security in code trial by the unauthorized people.

(3) VALIDATION

Press [#] key once. Two-beep confirms the entry

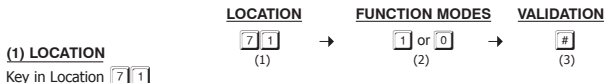
**(2) FUNCTION MODES FOR PACIFIER TONES**

Pacifier Tone is the Beep Tones from the keypad, which include the tones of Successful Key entry (1 beep) and the Unsuccessful User Code/Card entry (5 beeps).

NOTE:

The beeps for the Warning and the Power-up Delay do not belong to pacifier tones and can not be OFF.

[1] --- Pacifier Tone ON – (Default)

All the Pacifier Tones available from the keypad are enabled. They are the response tones indicating the operation status of the keypad after a Card/User Code is entered.

[0] --- Pacifier Tone OFF

All the Pacifier Tones are OFF. Good for place needs for a silent environment.

(3) VALIDATION

Press [#] key once. Two-beep confirms the entry

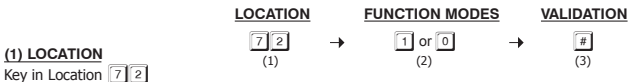
OUTPUT OPERATION ANNOUNCER**(Location 72)****(2) FUNCTION MODES FOR OUTPUT ANNOUNCER**

Output announcer gives notification beep on the operation status of the outputs. There are two notification modes available for the selection. The notification is also OFF while the Pacifier Tone OFF mode in the Location 71 is selected.

NOTE:

In multi-station operation, the output announcer only goes to the keypad that has been operated but not all the keypads in the system.

0 --- No Notification

The output operation notification is OFF but does not affect the normal pacifier tones.

1 --- 1 Second Long Notification -- (Default)

1 second notification beep is given when the output relay activates. It is prepared to notify the person outside the door when the lock is released and the door can be opened. It is good for door lock that gives no sound when it activates, such as a magnetic lock.

2 --- 2 Short Beeps Notification

2 short beeps notification is given when the output relay activates.

(3) VALIDATION

Press **#** key once. Two-beep confirms the entry

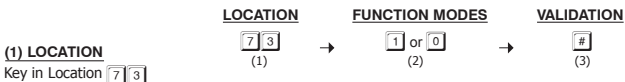
STATUS LED FLASHING ON-OFF DURING STANDBY**(Location 73)****(2) FUNCTION MODES FOR STANDBY FLASHING LIGHT**

Some people find the flashing light of the status LED (the amber LED) is annoying during standby, especially at the night time. The standby flashing can be ON-OFF with the setting here.

1 --- Standby Flashing ON -- (Default)

The Status LED gives Standby Flashing all the time. It also gives the light indications showing the operation status of the system.

0 --- Standby Flashing OFF

The Standby Flashing is OFF but it does not affect the system status indications.

(3) VALIDATION

Press **#** key once. Two-beep confirms the entry

INTELLIGENT EGRESS BUTTON – AN UNIQUE FEATURE OF THE KEYPAD

INTRODUCTION

Most of the keypads for access control are just for controlling "Going In" from outside. It is not enough for today's access control systems. In fact, controlling "Going Out" is also very important in some public passage areas those are not allowed to use locks or digital keypads for stopping of "Going Out" due to safety reasons. Such as hospitals, kindergartens, elderly homes, convenient stores, emergency exits etc.. The wardens, teachers, shopkeepers and the guards are always required to keep an eye on people to prevent unattended leaving, shoplifting, and unauthorized use of the emergency exits.

The Intelligent Egress Button can be programmed to do something to get attention from the person on duty before the door is opened. The button offers programmable egress delay, delay with warning, holding button for the delay, momentary button contact with warning for the delay and even gives alarm when a controlled door is opened.

Locations 90 is the place for setting the desired functions for the Egress Button.

The functions programmed to the Egress Button do not affect the normal operation of the keypad. The operation of the keypad with Code or Card is always in the first priority to give instant action to the output relay 1 for door strike.

It is **NOT** required to program the Egress Button with the special function in normal use. Just leave it on its default values.

WHERE AND WHY "GOING OUT" NEEDS ATTENTION

Examples for some areas may need an Intelligent Egress Button:

Hospital:

Some of the patients are not allowed to leave the ward without doctor's permission. An egress button with exit delay and warning beeps will help the nurse or warden to get attention to the door when the egress button is pressed. Further setting of the egress button with holding contact delay even gives higher level of security to a controlled door.

Kindergarten:

Young children are always active. Some of them may be willing to go out to explore their ways of playing. For safety reason, teachers have to watch all of them in the attended area. Leaving school alone without the companion of parents or teacher is dangerous to young children. An egress button with delay and warning beeps will be helpful to prevent the children trying to go out without getting the attention of the teacher.

Elderly Home:

The elderly needs constant attention and care. Some old people have poor memory. They may forget the way to come back if they leave home alone. An egress button with delay and warning beep will easily get the attention of the warden before the door is open.

Convenient Store:

Most of the convenient stores have just only one or two shopkeepers on duty. They are usually the cashier. Shoplifting may easily happen while the shopkeeper is busily serving customers at the cashier desk. A holding contact egress button with delay and warning beeps may help to stop most of the shoplifting. As the thief knows that he is gotten attention by the shopkeeper before the door is open.

High Traffic Passage:

A short buffer time may be necessary for opening a door outward after pressing the egress button for those exits open to a high traffic passage. An egress button with short delay and warning beeps helps the user to pay attention to the people passing by to prevent hitting them when the door is pushed outward.

Emergency Exit:

Emergency Exit is not open to the public for daily use. It is for emergency case only. It is usually closed and watched by guards. The egress button of this keypad can be programmed to offer exit delay with warning beeps and even gives alarm output to trigger an alarm system when the door is forced to open or the door is open after the exit delay expired. It is a useful tool to get attention of the person on duty.

WARNING

Do not enable Egress Delay if instant door open for leaving is the main concern in your area.

Make sure the Egress Delay does not affect the safety in your service area before enabling the function in Location 90.

The default setting of the system is NO DELAY.

**(1) LOCATION**Key in Location

9

0

(2) CONFIGURATIONS OF THE EGRESS WARNING AND ALARM

Key in the number to enable 1 of the 6 configurations described below:

**1

 --- Momentary Contact Mode without Warning -- (Default)**

- Press the Button once. No warning or alarm is given during Egress Delay.
- Good for silent area. The people have to wait for the door open until the delay time reaches.

**2

 --- Momentary Contact Mode with Warning Beep**

- Press the Button once. The system gives Warning Beeps during the Egress Delay.
- Good for the place required attention. The keypad beeps during the people are waiting for the door open.

**4

 --- Holding Contact Mode without Warning**

- Press and hold the Button. No warning or alarm is given during the Egress Delay.
- Good for the silent area. The people require to press & hold the button until the delay time reaches for the door open.

**5

 --- Holding Contact Mode with Warning Beep**

- Press and hold the Button. The system gives Warning Beeps during Egress Delay.
- Good for the place required attention. The keypad beeps while the button is kept pressed during the people are waiting for the door open.

(3) EGRESS DELAY TIMER**0

 --- No Delay – (Default)**

Output 1 activates instantly (the door is released instantly) when the Egress Button is pressed.

**1

 -

9

9

 --- Egress Delay Timing**

Put a number of 1 to 99 into the box to enable the Egress Delay. The number is the time in second, which starts to count when the Egress Button is pressed. Output 1 activates (the door is released) when the delay time reaches.

NOTE:

- 1) Momentary Contact** -- The Egress Delay starts to count when the egress button is momentarily pressed. Output 1 activates automatically (door is released) when the delay time reaches.
- 2) Holding Contact** -- The user **MUST** hold the egress button in contact for the whole period of the Egress Delay time until Output 1 activates. If the egress button is released before the end of the Egress Delay, the timer will stop to count and reset.

For safety, it is necessary to put **a sticker next to the egress button** telling how to open the door if "Holding Contact" is enabled.

Example: A sticker for an egress button that is programmed with "Holding Contact" of 5 seconds.

Press & Hold The Button
5 Seconds Minimum
Until The Door Is Open

- 3) The Egress Delay does not affect the operation of the User Codes/Cards for Output 1. The User Codes/Cards always give INSTANT action.**

(4) VALIDATION

Press **[#]** key once. Two-beep confirms the entry

EXAMPLES:

Example 1: Set Egress Button in Momentary contact of 5 seconds with delay & warning beep

[9][0] **[2]** **[5]** **[#]**
(a) (b) (c) (d)

(a) Egress function programming, (b) Momentary contact with warning, (c) Delay time of 5 seconds to release door, (d) Entry confirmation

Example 2: Set Egress Button in Holding contact of 10 seconds with warning beep

[9][0] **[5]** **[1][0]** **[#]**
(a) (b) (c) (d)

(a) Egress function programming, (b) Holding contact mode with warning, (c) Holding time of 10 seconds to release door, (d) Entry confirmation

Example 3: Set Egress Button in Momentary contact without delay (This is the default setting)

[9][0] **[1]** **[0]** **[#]**
(a) (b) (c) (d)

(a) Egress function programming, (b) Momentary contact without delay, (c) Release door instantly, (d) Entry confirmation

OPERATION MODES**(Location 94)**

The keypad is programmable for keypad mode to work stand-alone for door control directly or for server mode to work with a split-decoder for high security access control.

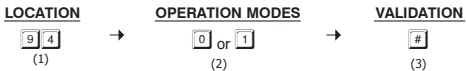
**(1) LOCATION**

Key in Location 

(2) OPERATION MODES** – Keypad Mode (Default)**

Keypad Mode sets the keypad for stand-alone operation to provide its available functions. It is compatible with the auxiliary readers/keypads for multi-station expansion.

 – Server Mode

Server Mode sets the keypad to compatible with both the decoder for split-decoded operation and the auxiliary readers/keypads for multi-station expansion. A split decoded keypad system uses the keypad(s) for human interface outside and the internal decoder for door lock control to prevent sabotage.

(3) VALIDATION

Press  key once. Two-beep confirms the entry

CLOSE PROGRAMMING MODE**(**)**

Always close programming mode with * * to set system back to normal Operation after programming.

The  button is equivalent to the  button in the keypad with bell button.

VALIDATION

  ----- System is back to normal operation mode





PROGRAMMING MAKE SIMPLE – For General Users

The DK-2891 is a multi purpose keypad. It has many functions for user's selection. For those general users taking the keypad for door strike only, most of the features can be kept in their Default values. Only the User Codes / Cards and a private Master Code are required to program.

The keypad accepts **1) Card only, 2) Code only, 3) Card + Code or 4) Card + Common User Code** to operate its outputs.

PROGRAMMING

NOTE:







- The  button is equivalent to the  button in the keypad with bell button.
- Wait 1 minute until the end of power up delay, or keyin  to stop the power-up delay instantly and set the keypad to normal operation.

1) Set System in Programming Mode with The Factory Set Master Code 0 0 0 0

  ---- 2 beeps, system is in Programming Mode

Note: If the Master Code is forgotten, use the DAP Code to set the system into programming mode. See **DAP CODE 2828** in page 13 for the details.

2) Change The Factory Set Master Code to Owner's Private Master Code for Security Reason











   ---- 2 beeps, 3 2 8 9 is a Master Code for example here only. It replaces the old master code 0000.

3) Record an "EM Card" to Operate The Output 1 for Door Open

    
(a) (b) (c) (d) (e)

- 10 = Programming Location for Output 1
- 1 = Programming option for EM Card only
- 001 = One of the 1,000 User IDs for the User Code/Card from 000-999
- Read Card = Put the Card close to the card reader
- # = Confirm the card is read, 2 beeps

4) Set an "User Code" to Operate The Output 1 for Door Open

    
(a) (b) (c) (d) (e)

- 10 = Programming Location for Output 1
- 2 = Programming option for User Code only
- 002 = One of the 1,000 User IDs for the User Code/Card from 000-999
- 8321 = The User Code for door open. It is for example here only
- # = Confirm the User Code, 2 beeps

5) Record an "EM Card + User Code" to Operate The Output 1 for Door Open

- (a) 10 = Programming Location for Output 1
(b) 3 = Programming option for EM Card + User Code. (The User Code can be repeated use or proprietary)
(c) 003 = One of the 1,000 User IDs for the User Code/Card from 000-999
(d) Read Card = Put the Card close to the card reader
(e) 6123 = The User Code to be used with the EM Card. It is for example here only.
(f) # = Confirm the Card+Code is stored, 2 beeps

6) Record an "EM Card + Common User Code" to Operate The Output 1 for Door Open

- (a) 10 = Programming Location for Output 1
(b) 4 = Programming option for EM Card + Common User Code
(c) 004 = One of the 1,000 User IDs for the User Code/Card from 000-999
(d) Read Card = Put the Card close to the card reader
(e) # = Confirm the card is read, 2 beeps, the Common User Code goes to this User ID automatically
(f) A Common User Code (for example: 1 3 5 7) **MUST** be set at the Programming **Location 03 first**. Common code can be used for all the EM Cards in this operation mode.

REMARK:

If more User Codes and Cards are required for Output 1, repeat the procedures (3) , (4) , (5) or (6) above with other User IDs, such as 005, 006, 007 --- 999 etc. Total 1,000 users are allowed. See Programming Location 10 for the details.

7) Close The Programming Mode

---- 2 beeps

The programming mode is closed. The keypad is back to normal operation mode

OPERATION

1) Open The Door with EM Card

--- 2 beeps, the door is open

2) Open The Door with User Code

 --- 2 beeps, the door is open

3) Open The Door with EM CARD + User Code

 --- 2 beeps, the door is open

4) Open The Door with EM CARD + Common User Code

 --- 2 beeps, the door is open

PROGRAMMING SUMMARY CHART

LOCATION	FUNCTION	ENTRY LIMITS & CODE OPTIONS	CODE ENTRY	FACTORY DEFAULT
0 1	Master Code	4-8 Digits	<input type="text" value="0 1"/> <input type="text" value="MASTER CODE"/> <input type="text" value="#"/>	NIL
0 2	Super User Code	4-8 Digits	<input type="text" value="0 2"/> <input type="text" value="SUPER USER CODE"/> <input type="text" value="#"/>	NIL
0 3	Common User Code for O/P 1	4-8 Digits	<input type="text" value="0 3"/> <input type="text" value="COMMON USER CODE 1"/> <input type="text" value="#"/>	NIL
0 4	Common User Code for O/P 2		<input type="text" value="0 4"/> <input type="text" value="COMMON USER CODE 2"/> <input type="text" value="#"/>	NIL
1 0	User Codes / Cards for O/P 1	CODE 1 – MEDIA: 1---EM Card 2---Private User Code 3---EM Card+Sec User Code 4---EM Card+Com User Code 5---Deletion of User Code	<input type="text" value="1 0"/> <input type="text" value="CODE1"/> <input type="text" value="CODE2"/> <input type="text" value="CODE3"/> <input type="text" value="#"/>	NIL
2 0	User Codes / Cards for O/P 2	CODE 2 – USER ID: 000-999---Group 1(10) 001-100---Group 2(20) 001-100---Group 3(30) CODE 3 – USER CODES / Cards: 4-8 Digits / Cards	<input type="text" value="2 0"/> <input type="text" value="CODE1"/> <input type="text" value="CODE2"/> <input type="text" value="CODE3"/> <input type="text" value="#"/>	NIL
4 0	Visitor Codes	CODE 1 – VISITOR ID: 01-50 CODE 2 – VALID PERIOD: 00---One Time 01-99 Hours CODE 3 – VISITOR CODE: 4-8 Digits	<input type="text" value="4 0"/> <input type="text" value="CODE1"/> <input type="text" value="CODE2"/> <input type="text" value="CODE3"/> <input type="text" value="#"/>	NIL
5 1	O/P Mode for O/P 1	OUTPUT MODE & TIME: 0--- Start / Stop 1---99999 Seconds, Momentary	<input type="text" value="5 1"/> <input type="text" value="O/P MODE & TIME"/> <input type="text" value="#"/>	5 Seconds
5 2	O/P Mode for O/P 2		<input type="text" value="5 2"/> <input type="text" value="O/P MODE & TIME"/> <input type="text" value="#"/>	5 Seconds
5 5	Real-Time-Clock	CURRENT REAL TIME: 00:00-23:59	<input type="text" value="5 5"/> <input type="text" value="CURRENT TIME"/> <input type="text" value="#"/>	NIL
5 6	Start & Stop Times for Inhibition	START TIME: 00:00-23:59 STOP TIME: 00:00-23:59	<input type="text" value="5 6"/> <input type="text" value="START TIME"/> <input type="text" value="STOP TIME"/> <input type="text" value="#"/>	NIL
6 0	Personal Safety & Lock-Up	LOCK-UP CODE: 1---10 Trial, Lock-Up 60 Sec. 2---10 Trial, Activates Dussess 5-10---5-10 Trial, Lock-Up 15 Minutes 00---No Lock-Up	<input type="text" value="6 0"/> <input type="text" value="LOCK-UP CODE"/> <input type="text" value="#"/>	Code = 1, 10 Trials, Lock-Up 60 Seconds
7 0	Code Entry Mode	ENTRY MODE: 1---Auto Mode 2---Manual Mode	<input type="text" value="7 0"/> <input type="text" value="ENTRY MODE"/> <input type="text" value="#"/>	Mode = 2, Manual Mode
7 1	Pacifier Tone ON-OFF	FUNCTION MODE: 0---OFF 1---ON	<input type="text" value="7 1"/> <input type="text" value="FUNCTION MODE"/> <input type="text" value="#"/>	Mode = 1, Pacifier Tone ON
7 2	Output Announcer	FUNCTION MODE: 0---NO Notification 1---1 Second Long Beep 2---2 Short Beeps	<input type="text" value="7 2"/> <input type="text" value="FUNCTION MODE"/> <input type="text" value="#"/>	Mode = 1 1 Second Long Beep
7 3	Standby LED Flashing	FUNCTION MODE: 0---OFF 1---ON	<input type="text" value="7 3"/> <input type="text" value="FUNCTION MODE"/> <input type="text" value="#"/>	Mode = 1, Flashing ON

LOCATION	FUNCTION	ENTRY LIMITS & CODE OPTIONS	CODE ENTRY	FACTORY DEFAULT
9 0	Egress Delay Warning & Alarm	CODE 1 – FUNCTION MODE: 1---Momentary, No warning 2---Momentary, with warning 4---Hold Contact, No warning 5---Hold Contact, with warning CODE 2 – DELAY TIME: 0---No Delay 1-99 Seconds	<input type="text" value="9"/> <input type="text" value="0"/> <input type="text" value="CODE 1"/> <input type="text" value="CODE 2"/> <input type="text" value="#"/>	Mode = 1 Momentary, No warning TIME = 0 No Delay
9 4	Operation Mode	FUNCTION MODE: 0---Keypad Mode 1---Server Mode	<input type="text" value="9"/> <input type="text" value="4"/> <input type="text" value="MODE"/> <input type="text" value="#"/>	Mode = 0 Keypad Mode

SYSTEM CODES	FUNCTION	CODE ENTRY	RESULTS
0 0 0 0	Factory Set Master Code for User to set system in programming Mode at the first time. THIS IS NOT A PERMANENT SYSTEM CODE & IT IS CHANGED IF A NEW MASTER CODE IS PROGRAMMED.	<input type="text" value="0"/> <input type="text" value="0"/> <input type="text" value="0"/> <input type="text" value="0"/> * * OR <input type="text" value="NEW MASTER CODE"/> * *	System in Programming Mode
9 9 9 9	REFRESH CODE -- Refresh the system and set all its function back to default values.	<input type="text" value="9"/> <input type="text" value="9"/> <input type="text" value="9"/> <input type="text" value="9"/> #	All programmed data are cleared and back to the default values except the Master Code
2 8 2 8	DAP CODE -- Direct access to programming mode. Valid only in the power-up delay period	<input type="text" value="2"/> <input type="text" value="8"/> <input type="text" value="2"/> <input type="text" value="8"/> #	System in Programming Mode
0 9 9 9	USER Codes / Cards whole group clearing Code for the selected Location LOCATIONS: 10--- User Group 1 20--- User Group 2 40--- Visitor Group	<input type="text" value="LOCATION NO."/> <input type="text" value="0"/> <input type="text" value="9"/> <input type="text" value="9"/> <input type="text" value="9"/> #	Whole group of users in the selected location are cleared
**	Exit Programming Code	* *	The system back to normal operation after programming

APPLICATION EXPANSIONS

Apart from standard-alone operation, DK-2891 is expandable to be a Multi-station System or a High Security Multi-station Split-decoded System with its Data I/O Bus for the connection of the optional auxiliary keypad(s) and decoder. The wiring is very simple. Just connect all the related devices in parallel with the Data I/O Bus. The DK-2891 is the server that manages the data among them.

A Multi-station System provides higher security in access control and user convenience to operate an electric lock at different locations. Such as a dual keypad system for area needs controlling of going in and going out with user codes or EM cards.

A Split-decoded keypad system increases the overall security with keypad(s) installing outside and decoder installing inside. It prevents the door can be opened due to sabotage at the external keypad(s). A Split-decoded system is also compatible with the auxiliary keypads for multi-station operation. It is a perfect system for overall higher security and user convenience.

The application examples here show the connections of the auxiliary keypads and the decoder to the server keypad. Please contact your local agent for these optional devices if increasing security and user convenience to the system is required.

The auxiliary reader / keypads and the decoders are compatible with all the 2nd generation keypads in the DK-2800 MK-II series.

The version "A" auxiliary reader keypads are available, which provide Wiegand and RS-232 data outputs.

The Auxiliary Readers & Keypad (Optional)

AR-2802	AR-2806	AR-2807	AR-2809
			
Aux. Reader	Aux. Reader-Keypad	Aux. Reader-Keypad	Aux. Reader-Keypad

Connection Terminal

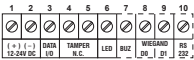
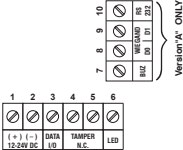
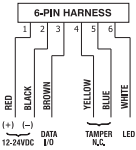
AR-2802 and AR-2807	AR-2806	AR-2809
 <p style="text-align: center;">Version "A" ONLY</p>	 <p style="text-align: center;">Version "A" ONLY</p>	 <p style="text-align: center;">6-PIN HARNESS</p>

The Split-decoders (Optional)

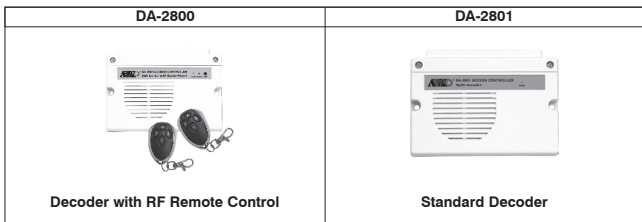

Connection Terminal

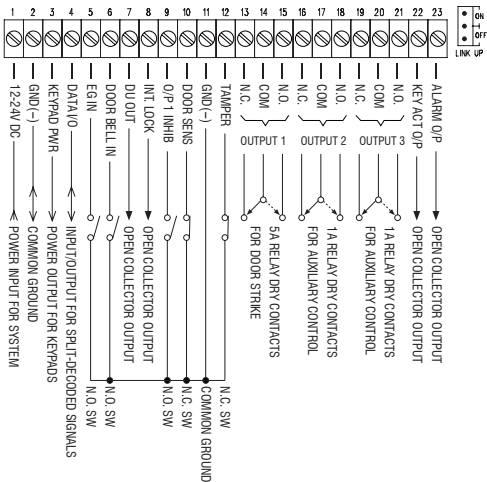

1) Dual-station Access Control Door Lock

Description

Owner can select an auxiliary reader AR-2802 or an auxiliary reader-keypad AR-2806, AR-2807 or AR-2809 and connect it with the master keypad DK-2891 to expand the system with dual-station for user convenience. Simply connect the reader or the reader-keypad in parallel with the Data I/O Bus of the master keypad. The auxiliary reader accepts all the cards that are programmed in the master keypad. If it is an auxiliary reader-keypad it accepts cards and user codes like the master keypad.

Note: Keep **Operation Mode** setting of the keypad in "**Keypad Mode (default)**" with **Location 94 = 0** in this application.

System Connection

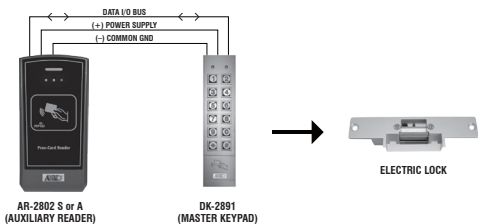

Wiring Diagram

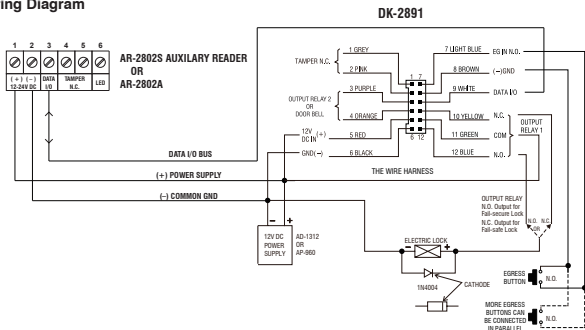

Dual-Station Access Control Door Lock

2) Multi-station Access Control Door Lock

Description

This is an expansion of application (1). The DK-2891 is expandable to a multi-station system for user convenience with the auxiliary readers AR-2802 and/or the auxiliary reader-keypads AR-2806, AR-2807 & AR-2809. Total 3 auxiliary readers or reader-keypads can be connected in parallel with the Data I/O Bus and they provide the same functions like the master keypad in using cards and user codes.

Note: Keep **Operation Mode** setting of the keypad in "**Keypad Mode (default)**" with **Location 94= 0** in this application.

System Connection

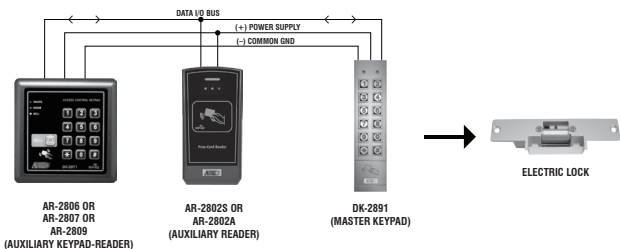

Wiring Diagram

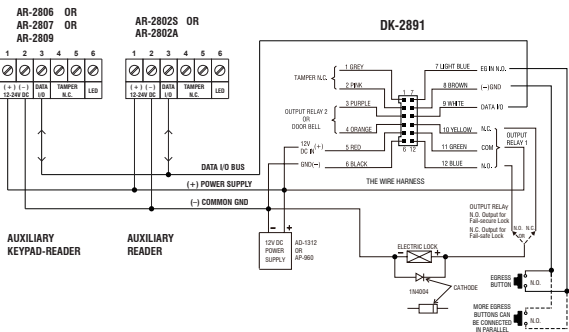

3) Split-decoded Access Control Door Lock

Description

Apart from stand-alone operation, the DK-2891 can be up-graded to high security Split-decoded operation with a decoder unit DA-2800 or DA-2801. The decoder is inside the house with all the input and output installations connecting to it. The DK-2891 manages the data in the system with its Data I/O Bus. The decoder operates the door lock and the appliances directly according to the commands from the keypad unit. This approach prevents the electric door lock or appliance be operated due to sabotage at the external keypad.

Note: Make **Operation Mode** setting of the keypad in “**Server Mode**” with **Location 94 = 1** in this application.

System Connection

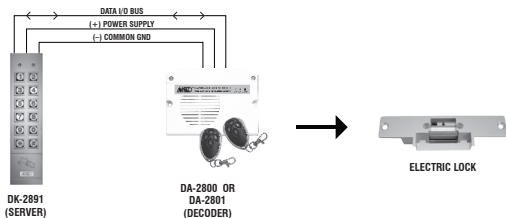

Wiring Diagram

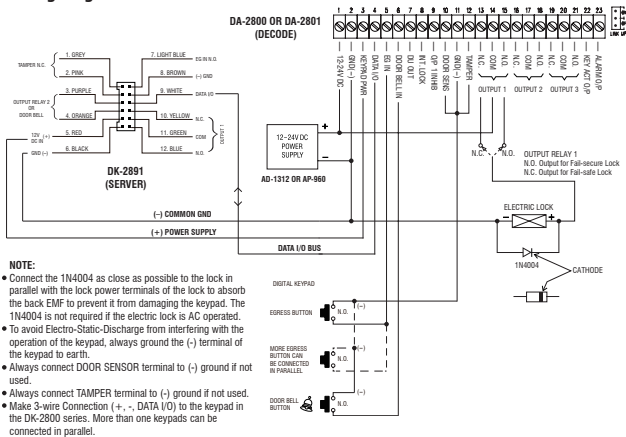

NOTE:

- Connect the 1N4004 as close as possible to the lock in parallel with the lock power terminals of the lock to absorb the back EMF to prevent it from damaging the keypad. The 1N4004 is not required if the electric lock is AC operated.
- To avoid Electro-Static-Discharge from interfering with the operation of the keypad, always ground the (-) terminal of the keypad to earth.
- Always connect DOOR SENSOR terminal to (-) ground if not used.
- Always connect TAMPER terminal to (-) ground if not used.
- Make 3-wire Connection (+, -, DATA I/O) to the keypad in the DK-2800 series. More than one keypads can be connected in parallel.

4) Split-decoded Multi-station Access Control Door Lock

Description

This is an expansion of application (3). The DK-2891 is expandable to a multi-station system in Split-decoded operation. It is compatible with the auxiliary readers AR-2802 and the auxiliary reader-keypads AR-2806, AR-2807 & AR-2809. Total 3 auxiliary readers or reader-keypads can be connected in parallel with the Data I/O Bus. They provide the same functions like the master keypad in using cards and user codes. The DK-2891 that is the server of the system manages the data with its Data I/O Bus among the associated devices. This approach gives high security in sabotage prevention and user convenience.

Note: Make **Operation Mode** setting of the keypad in **“Server Mode”** with **Location 94 = 1** in this application.

System Connection

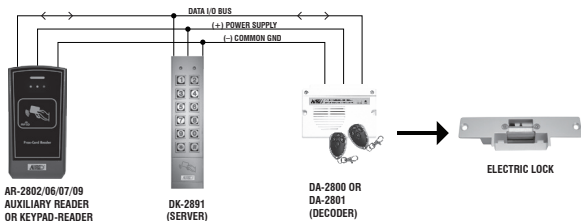

Wiring Diagram

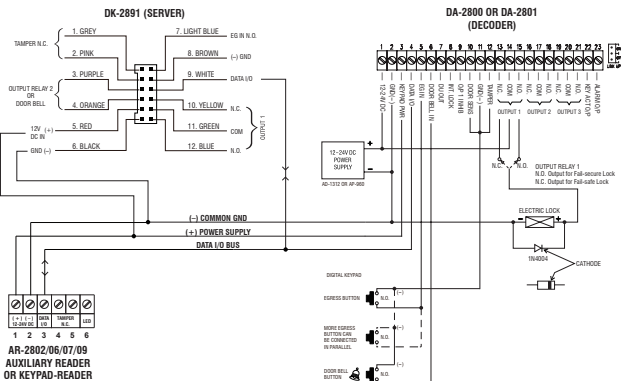

APPLICATION HINTS FOR THE AUXILIARY TERMINALS

(A) TAMPER N.C.

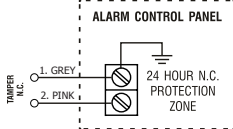

The tamper switch is Normally Closed while the keypad is secured on gang box. It is open when the keypad is removed from the gang box. To prevent sabotage, connect these terminals in series with a 24 hour N.C. protection zone of an alarm system if required.

(B) OUTPUT 2 (DK-2891A ONLY)

(i) Shunting an N.C. Zone

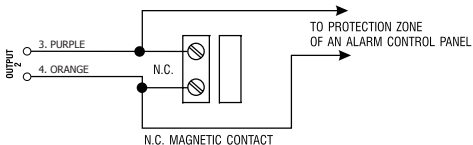

- Put Output 2 jumper to N.O.
- Use the Normally Open (N.O.) output contact to shunt a Normally Closed (N.C.) protection zone of an alarm system.
- Set output contact to Start / Stop Mode (Programming Option 52, Output Mode=0).

(ii) Alarm System Arm-Disarm Control

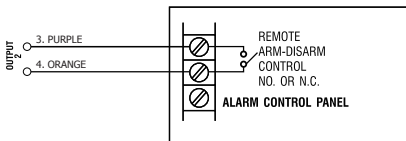

- Use the (N.O.) or (N.C.) output contact to make arm-disarm control of an alarm system.
- Consult your alarm control panel manual for the appropriate output contact for arm-disarm control. Usually set output 2 to Momentary mode (Programming Option 521, Location 52, Output Mode=1) for
- multi station systems and Start / Stop mode (Programming Option 520, Location 52, Output Mode=0) for single station systems.

(C) OUTPUT 2 -- Door Bell Button (DK-2891B ONLY)

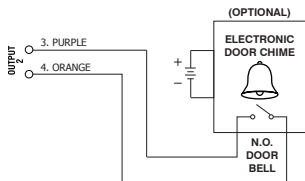

The output 2 of the DK-2891B is prepared for triggering a low power door chime. **DO NOT** use it as a high voltage power path for a door bell. The maximum power rating of the contact is 24V DC/1 Amp.

- Put Output 2 jumper to N.O.
- Connect the N.O. output contact in parallel with the door bell button.

AUXILIARY INFORMATION

- **DRY CONTACT**

A dry contact means that no electricity is connected to it. It is prepared for free connections. The Relay Output contacts provided in this keypad system are dry contacts.

- **N.C.**

Normally Closed, the contact is closed circuit at normal status. It is open circuit when active.

- **N.O.**

Normally Open, the contact is open circuit at normal status. It is closed circuit when active.

- **TRANSISTOR OPEN COLLECTOR OUTPUT**

An open collector output is equivalent to a Normally Open (N.O.) contact referring to ground. The transistor is normally OFF, and its output switches to ground (-) when active. The open collector can only provide switching function for small power but it is usually good enough for controlling of an alarm system. The Duress, Inter-lock and Key Active/Alarm Outputs of the keypad are open collector outputs.



**OPEN COLLECTOR
OUTPUT ----**

Output switches to
ground when activated

EQUIVALENT



**N.O. CONTACT
OUTPUT ----**

Output switches to
ground when activated



AEI PROTECT-ON SYSTEMS LIMITED
www.apo-hk.com



Ver. 201511_V2