



Network

Fisheye

XNF-9013RV

12MP AI IR Fisheye Camera



Key Features

- AI technology
 - Classified object type: Person/Face/Vehicle/License plate
 - Support Detection Shot
 - Object detection-Virtual line (Crossing/Direction), Virtual area (Loitering/Intrusion/Enter/Exit)
- Stereographic type fisheye lens
- Improved image quality
 - extreme WDR (2MP@60fps) by scene Analysis and Local contrast enhancement
 - WiseNR II , Auto prefer shutter control based on AI
- Resolution/Framerate
 - Original view-Max.30fps/25fps@3008x3008 (60Hz/50Hz)
 - Double panorama-Max.30fps/25fps@3584x1792 (60Hz/50Hz)
 - Single panorama-Max.30fps/25fps@3584x896 (60Hz/50Hz)
- WiseStreamIII based on AI
- Next level cybersecurity
 - Device Certificate (Root CA, pre-installed)
 - TPM 2.0 (FIPS 140-2 certified), Secure OS/boot/storage, Verified FW forgery
- Adjustable IR distance with WisePower : PoE+mode-13m, PoE mode-8m
- Mirco SD/SDHC/SDXC 2 slot: Max. 1TB (512GBx2ea)
- Reinforced durability
 - IP66, NEMA4X, IK19, Metal shielded RJ-45
 - Hard-coated dome bubble
- Additional accessories
 - Black Skin Cover (SBC-160BF), Tilted wall mount (SBP-160TMW1)

Compatible Accessories (Optional)



SBC-160BF

XNF-9013RV

12MP AI IR Fisheye Camera



Specifications

Video	
Imaging Device	1/2.3" 12MP CMOS
Resolution	Original view(1:1): 3008x3008~480x480, Double panorama(2:1): 3584x1792~640x320, Single panorama(4:1): 3584x896~640x160, Quad view: 3584x2688~640x480, Q1/Q2/Q3/Q4(4:3): 1792x1344~640x480
Max. Framerate	H.265/H.264: Original view-Max.30fps/25fps@3008x3008(60Hz/50Hz), Double panorama-Max.30fps/25fps@3584x1792(60Hz/50Hz) Single panorama-Max.30fps/25fps@3584x896(60Hz/50Hz) MJPEG: Max.30fps/25fps@1080x1080(60Hz/50Hz)
Min. Illumination	Color: 0.39 Lux (F2.2, 1/30sec), BW : 0Lux(IR LED on)
Video Out	CVBS : 1.0 Vp-p / 75Ω composite, 720x480(N), 720x576(P), for Installation USB: Micro USB Type B, 1280x720 for installation
Lens	
Focal Length (Zoom Ratio)	1.08mm fixed focal
Max. Aperture Ratio	F2.2
Angular Field of View	H: 187° / V: 187° / D: 187°
Min. Object Distance	0.5m(1.64ft)
Focus Control	Simple focus
Pan / Tilt / Rotate	
Pan / Tilt / Rotate Range	Lens Rotation
Operational	
Camera Title	Displayed up to 85 characters
Day & Night	Auto(ICR)
Backlight Compensation	BLC, HLC, WDR, SSSDR
Wide Dynamic Range	extremeWDR (120dB)
Digital Noise Reduction	WiseNR II (Based on AI engine), SSNR V
Motion Detection	8ea, 8point polygonal zones
Privacy Masking	32ea, polygonal zones - Color: Grey/Green/Red/Blue/Black/White - Mosaic
Gain Control	Off / Max Gain / Manual
White Balance	ATW / Narrow ATW / AWC / Manual / Indoor / Outdoor
Electronic Shutter Speed	Minimum / Maximum / Anti flicker (1/5~1/12,000sec) Prefer shutter control(Based on AI engine)
Video Rotation	Flip, Mirror
Analytics	- Analytics events based on AI engine : Object detection (Person/Face/Vehicle/License plate), IVA (Virtual line/Area, Enter/Exit, Loitering, direction, Appear/Disappear, intrusion) - Analytics events : Defocus detection, Motion detection, Tampering, Fog detection, Audio detection, Sound classification

Business Intelligence	Based on AI engine : People counting, Queue management, Heatmap
Alarm I/O	2 configurable I/O ports
Alarm Triggers	Analytics, Network disconnect, Alarm input
Alarm Events	File upload via FTP and e-mail Notification via e-mail SD/SDHC/SDXC or NAS recording at event triggers Alarm output PTZ Preset Handover Audio playback
Audio In	Selectable(mic in/line in/built-in mic) Supply voltage: 2.5VDC(4mA), Input impedance: 2K Ohm
Audio Out	Line out, Max. output level: 1Vrms
IR Viewable Length	Wise IR, PoE : 8m(26.25ft), PoE+ : 13m(42.65ft)
Network	
Ethernet	Metal shielded RJ-45(10/100BASE-T)
Video Compression	H.265/H.264: Main/Baseline/High, MJPEG
Audio Compression	G.711 u-law /G.726 Selectable G.726(ADPCM) 8KHz, G.711 8KHz G.726: 16Kbps, 24Kbps, 32Kbps, 40Kbps AAC-LC: 48Kbps at 16KHz
Smart Codec	Manual(5ea area), WiseStream II , WiseStreamIII(Based on AI engine)
Bitrate Control	H.264/H.265: CBR or VBR MJPEG: VBR
Streaming	Unicast(20 users) / Multicast Multiple streaming(Up to 10 profiles) Up to 5 virtual channel support
Protocol	IPv4, IPv6, TCP/IP, UDP/IP, RTP(UDP), RTP(TCP), RTCP,RTSP, NTP, HTTP, HTTPS, SSL/TLS, DHCP, FTP, SMTP, ICMP, IGMP, SNMPv1/v2c/v3(MIB-2), ARP, DNS, DDNS, QoS, UPnP, Bonjour, LLDP, SRTP (TCP, UDP Unicast)
Security	HTTPS(SSL) Login Authentication Digest Login Authentication IP Address Filtering User access log 802.1X Authentication(EAP-TLS, EAP-LEAP) Device Certificate(Hanwha Techwin Root CA)
Application Programming Interface	ONVIF Profile S/G/T/M SUNAPI(HTTP API) Wisenet open platform
General	
Webpage Language	English, Korean, Chinese, French, Italian, Spanish, German, Japanese, Russian, Swedish,, Portuguese, Czech, Polish, Turkish, Dutch, Hungarian, Greek
Edge Storage	Micro SD/SDHC/SDXC 2slot 1TB(512GBx2)
Memory	4096MB RAM, 512MB Flash
Environmental & Electrical	
Operating Temperature / Humidity	-40°C ~ +60°C (-40°F ~ +140°F) / Less than 95% RH POE+ Mode 55°C (Hysteresis 5°C) Wise IR 8m(26.25ft)
Storage Temperature / Humidity	-50°C ~ +60°C(-58°F ~ +140°F) / Less than 95% RH
Certification	IP66, IK10, NEMA4X
Input Voltage	PoE(IEEE802.3af, Class3), PoE+, 12VDC
Power Consumption	PoE: Max 12.95W, typical 9.4W, 12VDC: Max 12.9W, typical 9.0W PoE+: Max 23.0W, typical 9.4W, 12VDC: Max 22.0W, typical 9.0W
Mechanical	
Color / Material	White / Aluminum, Hard-coated dome bubble

RAL Code	RAL9003
Product Dimensions / Weight	Ø160x72mm(6.23x2.84"), 1,170g (2.58lb)
Hanging Mount (Dome)	SBP-167HMW
Skin Cover	SBC-160BF

Certifications & Standards

EMC	FCC 47 CFR 15 Subpart B Class A ICES-3(A)/NMB-3(A) CE/UKCA - EN 55032 Class A, EN 50130-4, EN 61000-3-2, EN 61000-3-3 VCCI CISPR 32 Class A RCM AS/NZS CISPR 32 Class A KS C 9832 Class A , KS C 9835
Safety	UL 62368-1, CAN/CSA C22.2 NO. 62368-1 IEC/EN 62471
Environment	IEC/EN 63000 IEC 60529 IP66, IEC 62262 IK10 NEMA 250 type 4X

DORI (EN62676-4 standard)

Detect (25PPM/ 8PPF)	34.9m(114.49ft)
Observe (63PPM/ 19PPF)	13.9m(45.60ft)
Recognize (125PPM/ 38PPF)	7.0m(22.96ft)
Identify (250PPM/ 76PPF)	3.5m(11.48ft)

XNF-9013RV

12MP AI IR Fisheye Camera



CAD

Unit:mm [inch]

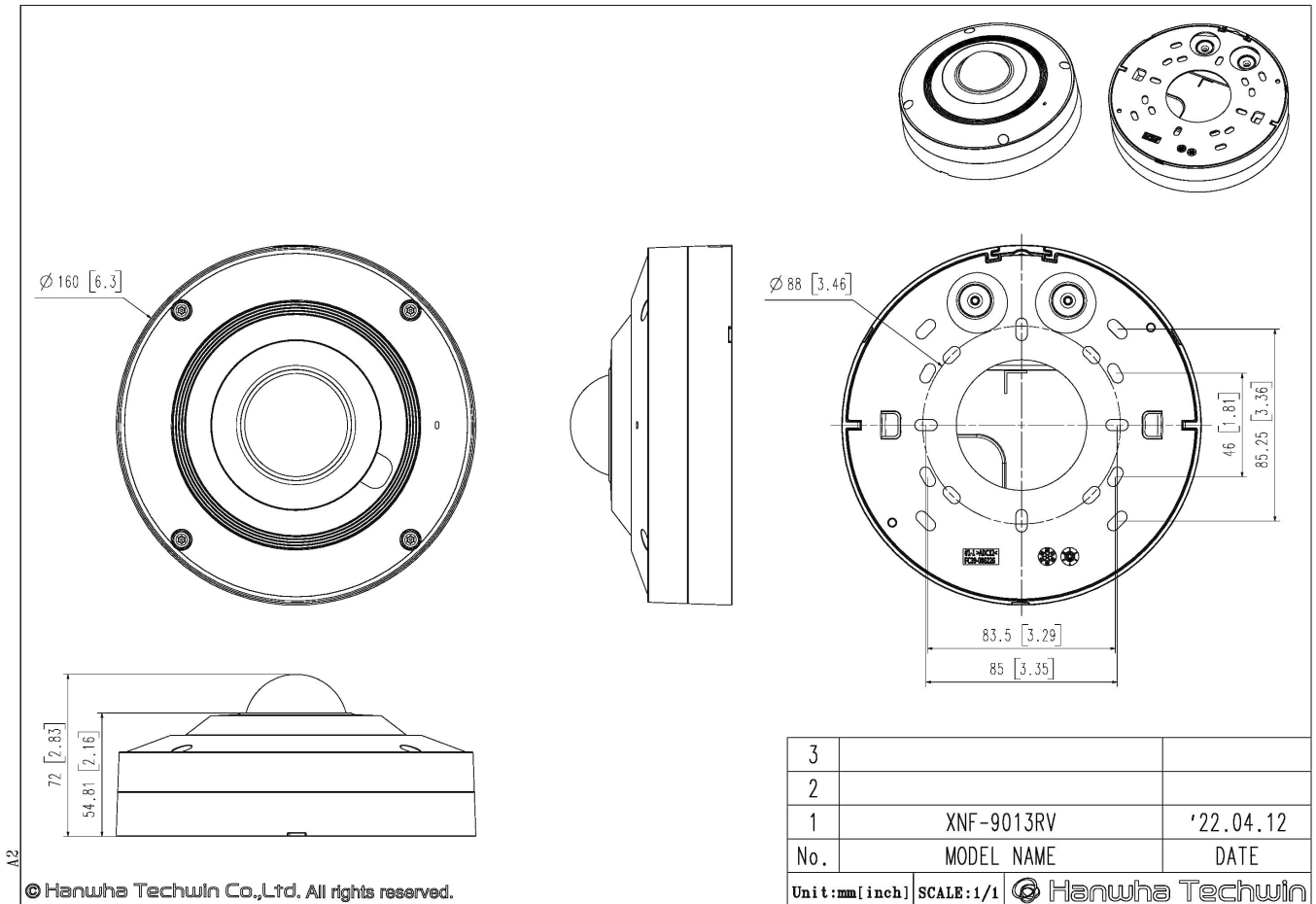

© Hanwha Techwin Co.,Ltd. All rights reserved.