

AIPHONE

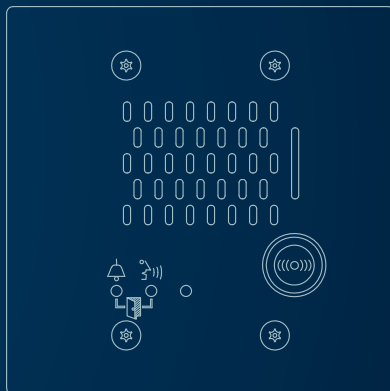

SYSTEM

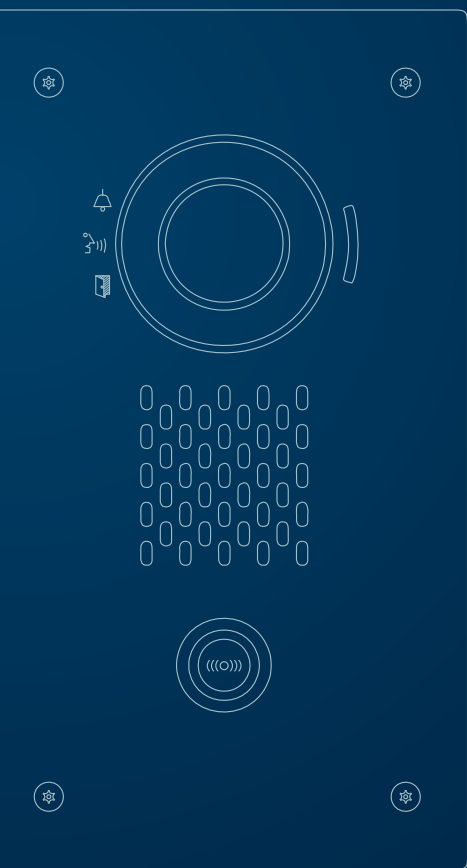

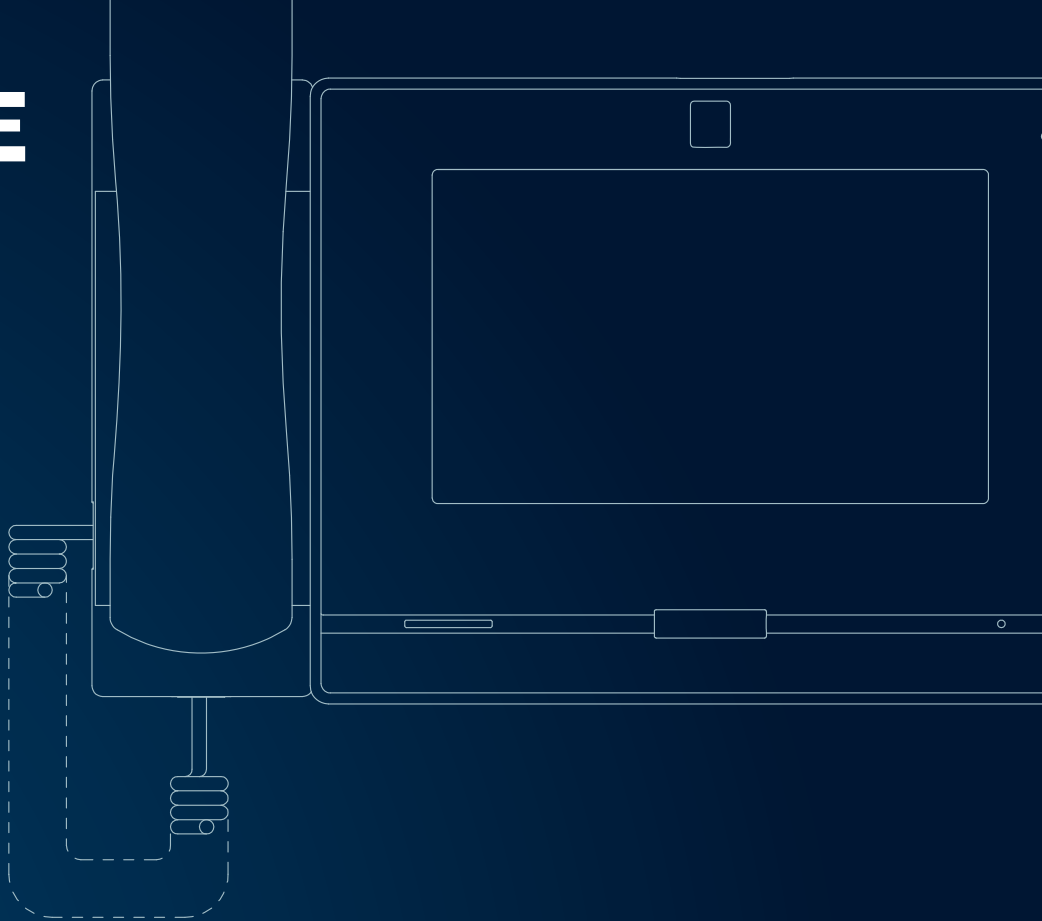
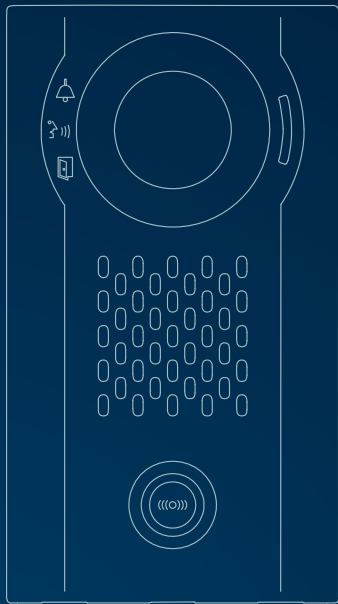
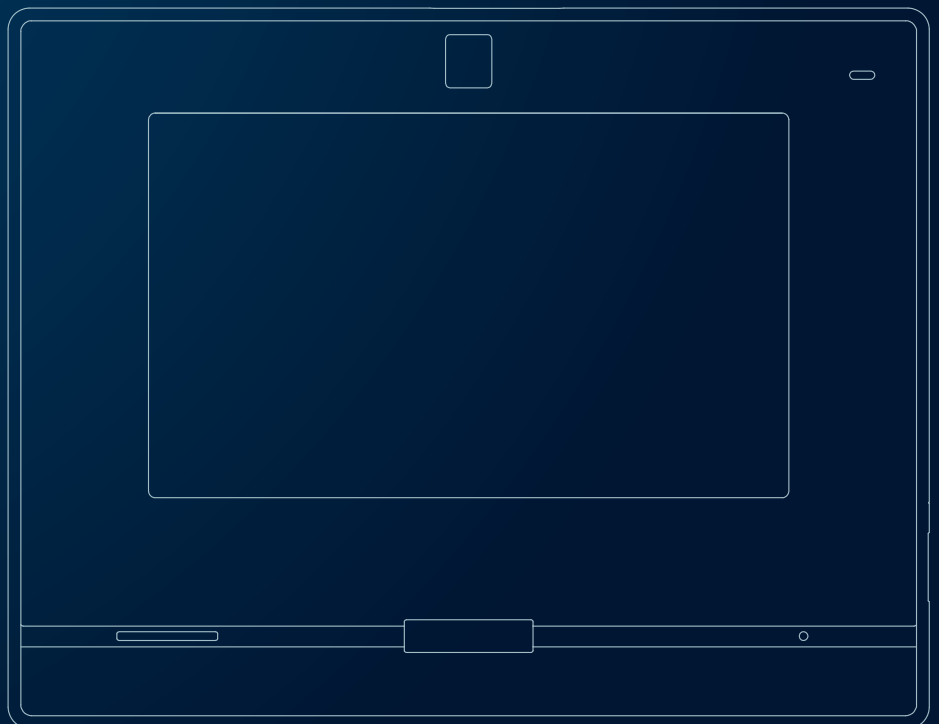
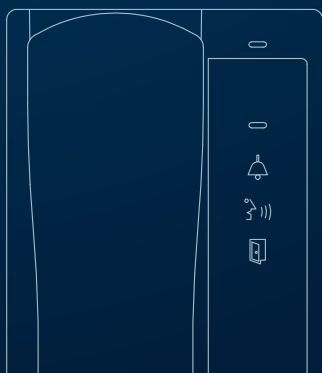

Greater flexibility, covering more applications.

IX System – getting the job done for a wide range of business applications, while providing connectivity and integration with third-party IP systems.

Full IP-based Peer to Peer Audio-Video Intercom System

Communicate between an infinite number of door / master stations with no distance limitations. Reduce costs as no server is required to build a system.

Integration with other IP-based systems

Utilizing an existing IP infrastructure, IX System can be integrated with Video Management Systems, Access Control Systems, and Network Camera Systems, etc. Combining security components saves time and resources during set-up and training. Moreover, IX System can be integrated with IP-PBX, which enables the IX System to be used as a part of your internal telephone network.

24/7 Monitoring / Recording

Video from door stations can be monitored and recorded with third-party VMS / NVR systems. Enhance security level for all types of applications.

Integrate and upgrade previously installed IX Systems

Use the existing network infrastructure while providing powerful new options.

Aiphone offers the ideal intercom system for a diverse range of applications that leverage your IP network.

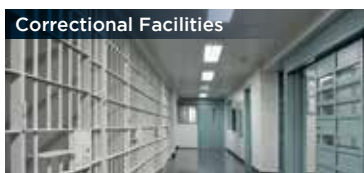
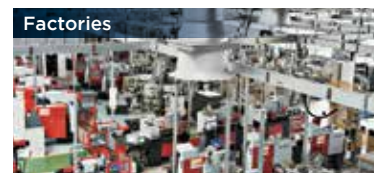

Broad coverage through network connections.

Full IP-network compatibility, simple installation, and excellent flexibility.

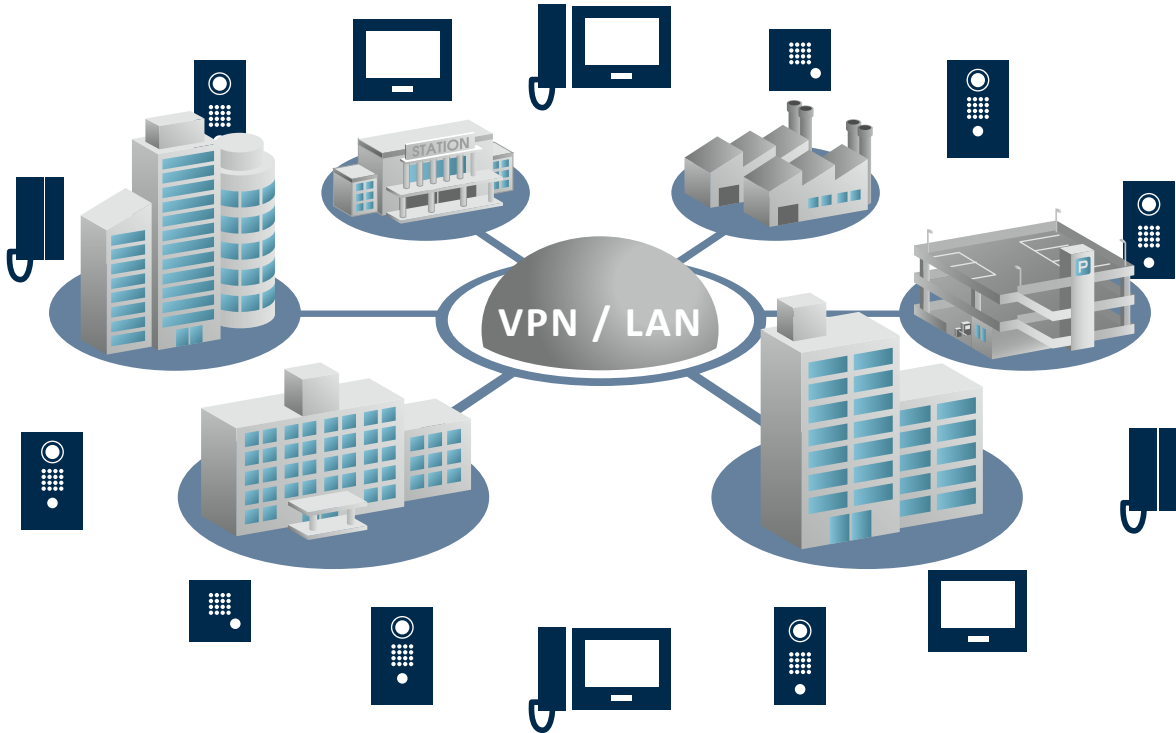

Unlimited number of IX units can be connected

Up to 9999* call address registrations in IX master stations. Extreme scalability - use for installations of any size.



No wiring distance limitations

LAN and VPN connections enable implementation over multiple interconnected networks and between remote locations. This allows for closed circuit communication and central control in large facilities, between corporate and satellite offices, and any type of application with multiple locations.

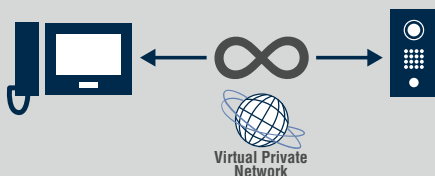

Peer to peer configuration results in space savings, reduced installation time, and lower cost

Simply connect the units to Power over Ethernet (PoE) switches. No need for a dedicated server, with the additional benefit of eliminating the risk of system downtime due to server malfunction.



PoE design

Electrical power is supplied over the LAN port connection.



New level of integration flexibility.

Enhanced security through integration.



Compatible with third-party systems

The IX System is compatible with the ONVIF Profile S interface specifications for network camera equipment. This allows the intercom to be used with third-party systems, enabling interoperability of integrated IP systems. The open API allows for configuring IP systems with greater flexibility.



Examples of Integration Use with a Video Management System and Access Control

Interconnection with an ONVIF Profile S-compatible network camera system lets you transform door stations into surveillance cameras for enhanced security and facial identification of visitors. Integrate with video management systems for 24/7 recording. Integration with third-party access control is also possible.

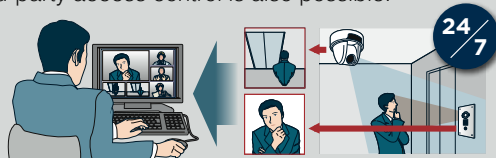

Clearly identify visitors with both the intercom and network camera.

Linking IP cameras with the IX System allows the user to view 2 video feeds simultaneously* from the master station. Increase security and situational awareness.



*only for IX-MV7-HB, IX-MV7-HW, IX-MV7-B and IX-MV7-W

IP-PBX Integration

IP-PBX integration enables the IX System to be used as a part of your internal telephone network. Make receive and transfer calls, answer visitors and release doors.

*Integration available for CISCO system only. For further details, please contact your local distributor.



Custom settings for all situations.

Call Queuing

Master stations can receive up to 20 incoming calls simultaneously. Caller information is displayed on a call queue list, making it possible to respond selectively to high-priority calls.



The above image is simulated.

Page to all stations or individual groups

Paging to all stations and paging to preset specific groups is possible. Message data registered in the master station can be transmitted manually or according to a schedule. Paging amplifiers and external sound sources can be connected for additional coverage and options.

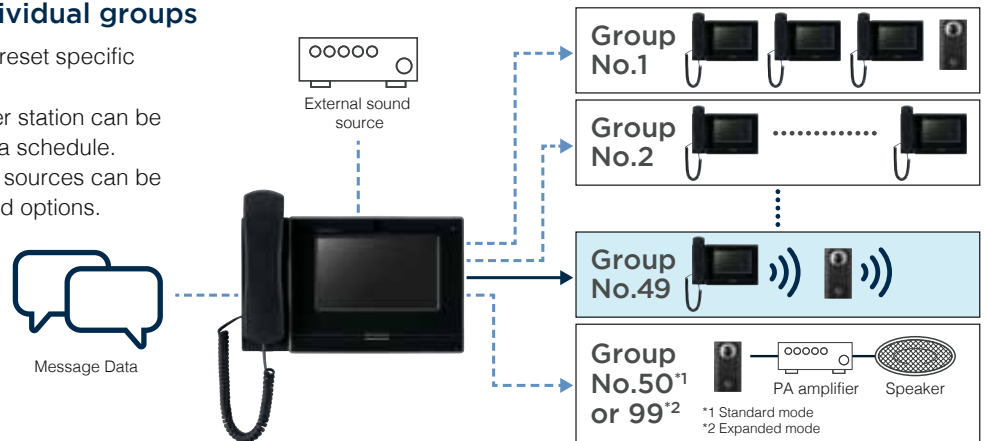

Customize with prerecorded messages

Create and import custom audio files for use as unique voice messages. For visitors at door stations, voice messages let them know the door and communication status.

Use custom messages as ring tones to identify locations and call priorities. For security guards / receptionists at master stations, customized voice messages help to identify incoming calls and special situations instantly.



Notification of call and communication status

Indicator lamps and sounds or voice messages provide notification of call and communication status for security and peace of mind.

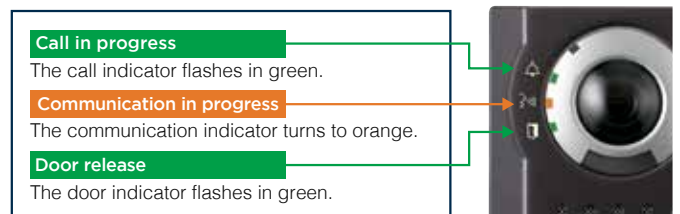

Unicast / Multicast

Depending on the network infrastructure, you can choose sending data via Unicast or Multicast. Paging to all stations included in a system can be done using Multicast. Using Unicast, paging up to 50 stations is possible.

Send E-mail reports

When master stations are called, IX System can send an E-mail attached with the visitor's picture up to 4* E-mail addresses. Error and health check reports can be also sent via E-mail.

*1 administrator, 3 user accounts.

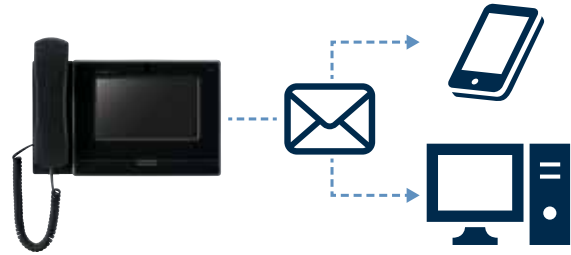

A wide range of call transfer features

The system offers multiple call transfer features that can be customised to meet user demands.

Manual transfer

Calls can be placed on hold and transferred to another master station manually by the operator.



Delay transfer

If no response occurs within a set interval, calls are automatically transferred to a pre-programmed master station.

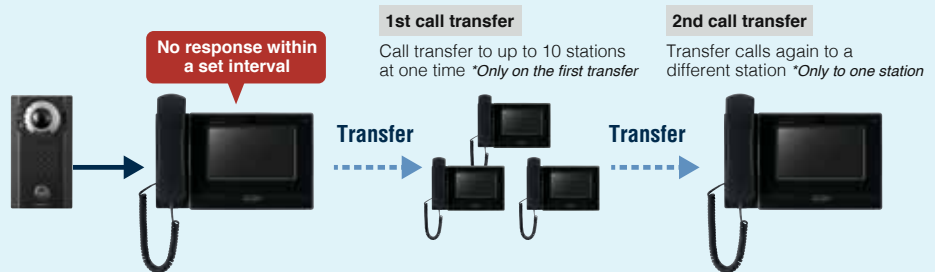

Absent transfer

Calls are automatically transferred to a different master station immediately.

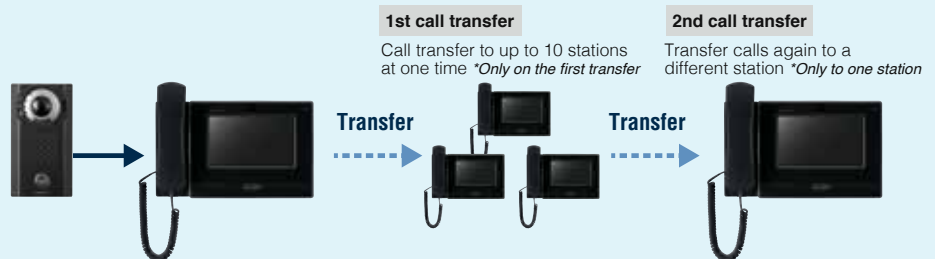

Schedule transfer

Calls are automatically transferred to a preset master station during scheduled times, such as after normal business hours.

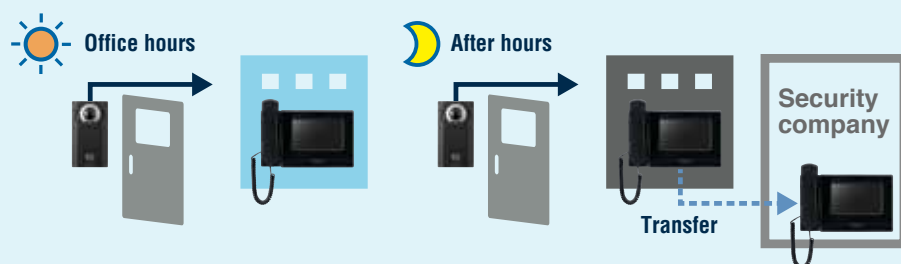

Application-specific individual calls and simultaneous calls to multiple devices

Multiple calling methods suitable for various applications can be provided. Meet all user communication needs at the installation premises.

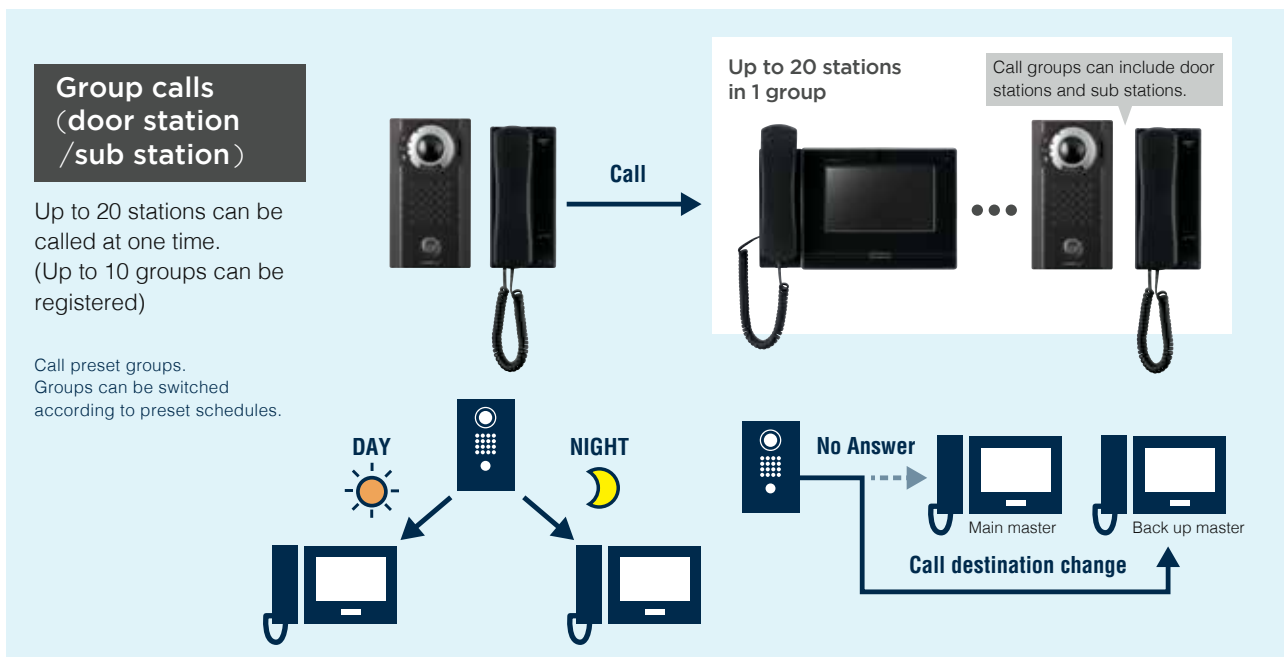

Powerful and clear sound in all situations

- Conversations can be heard clearly while talking even in places with background noise.
- Integrate with PA systems for even more flexibility and power.

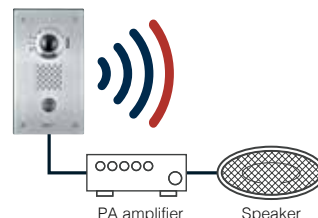

Audio and video recording

In addition to integration with a third party recording system, video and audio can be recorded on a micro SD card in the IX master stations and door stations.

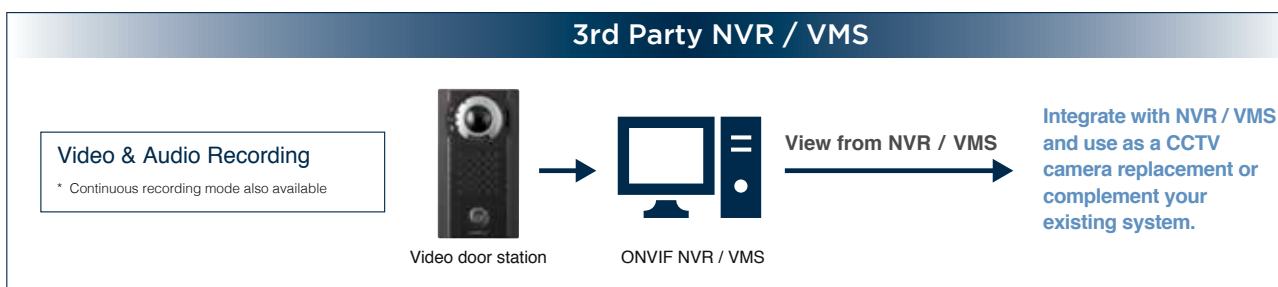
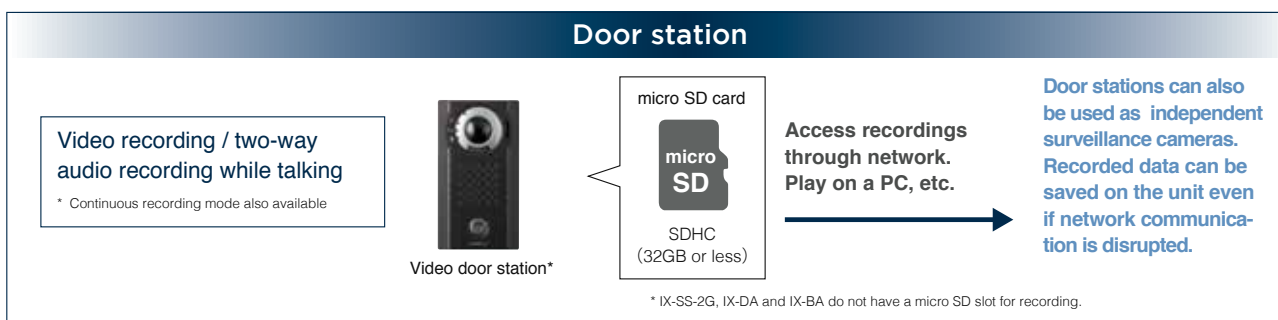
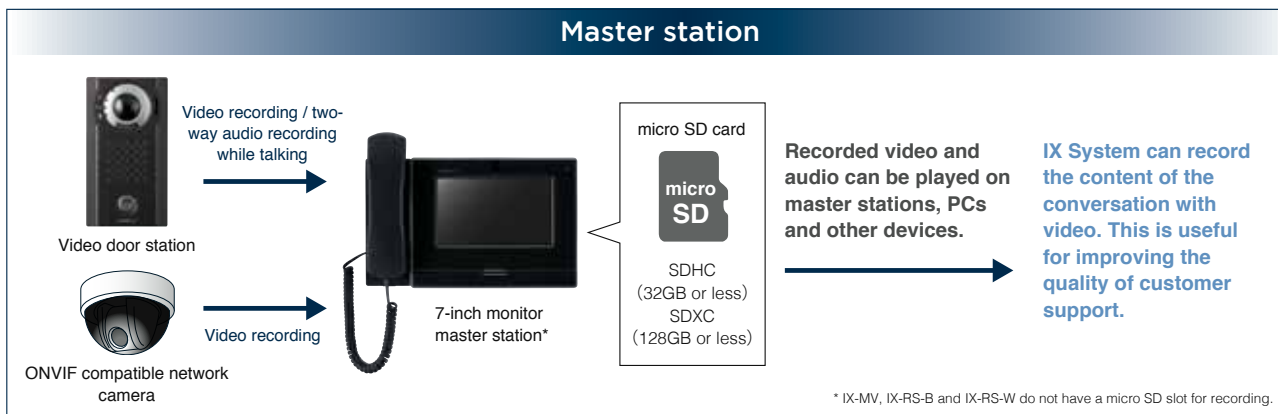

Use of a multi-purpose adaptor (IXW-MA)

Exclusive IX system accessory

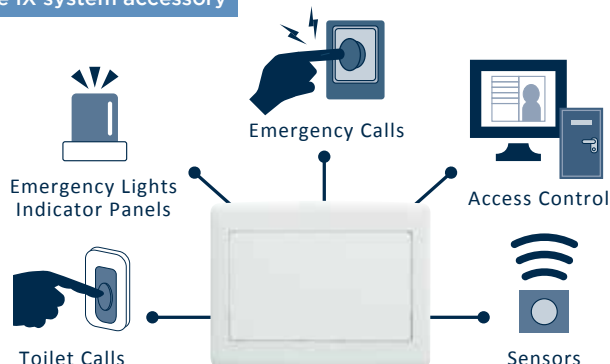

Specifications

- 4 Contact inputs
- 10 Relay outputs

Usage examples

- Link to various devices to allow two way control
- Connect toilet calls
- Access control management
- Connect emergency calls
- Connect sensors
- Connect lights / indicators

API

- Use API to add even more functionality*
- *For further details, please contact your local distributor.

Two-way video call

New IX master stations are embedded with a camera for two-way video communication.*

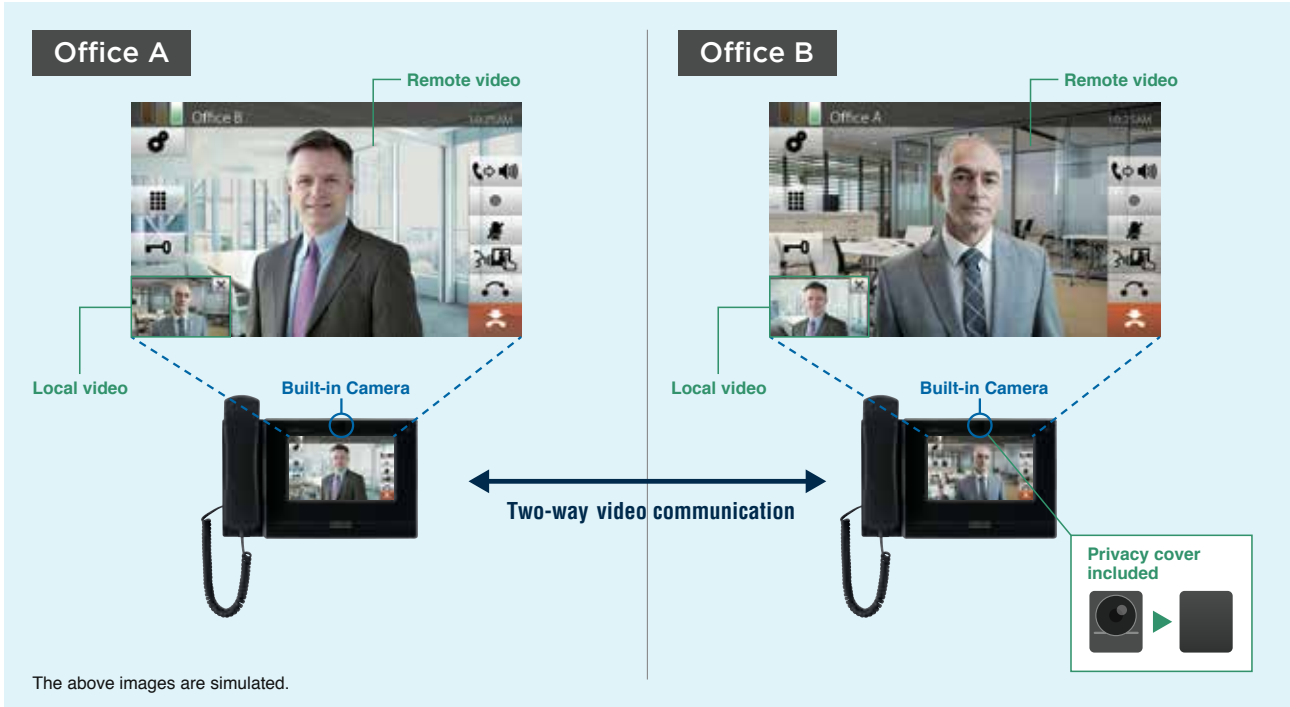

*only for, IX-MV7-HB, IX-MV7-HW, IX-MV7-B and IX-MV7-W

Reception mode

New IX master stations include a reception mode for reception desks. Communicate directly with tenant offices from unmanned receptions with video.*

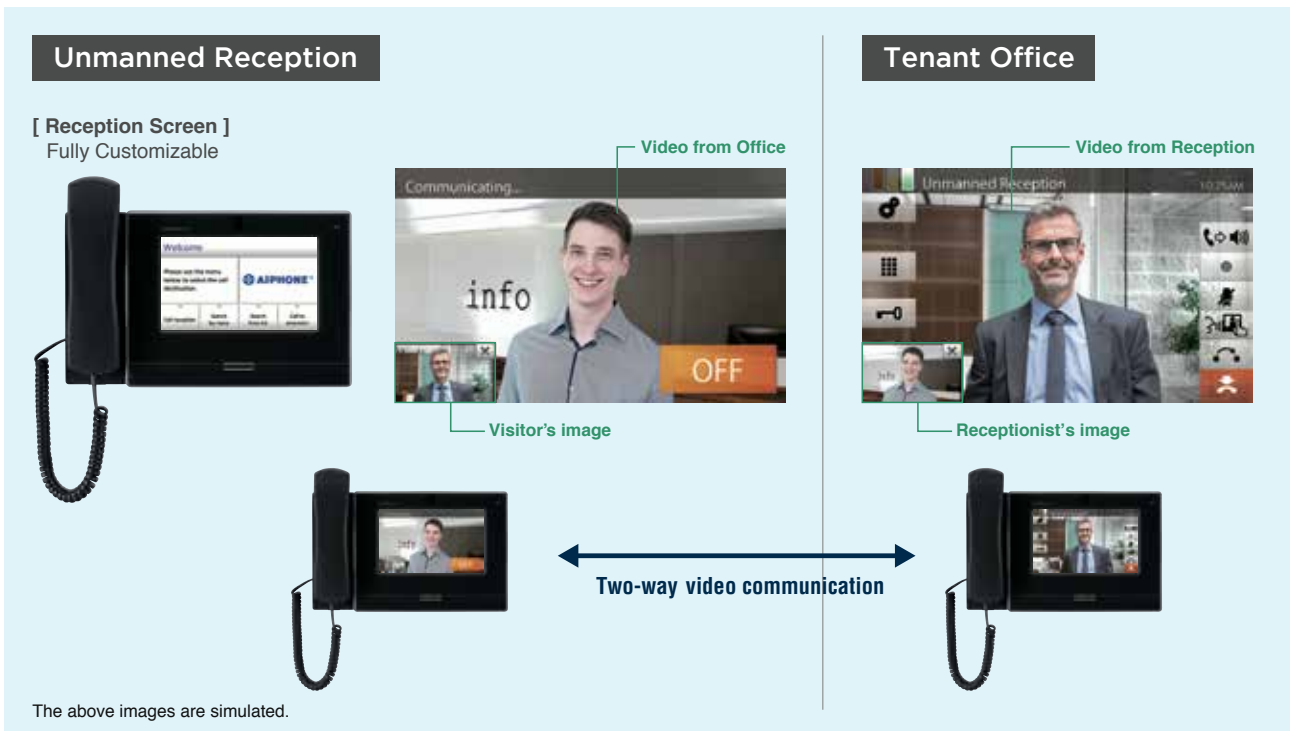

*only for, IX-MV7-HB, IX-MV7-HW, IX-MV7-B and IX-MV7-W

IP camera integration

Link IP cameras with IX units. This allows you to see 2 video images at the same time, convert audio-only stations to video stations or add intercom functionality to existing cameras.*

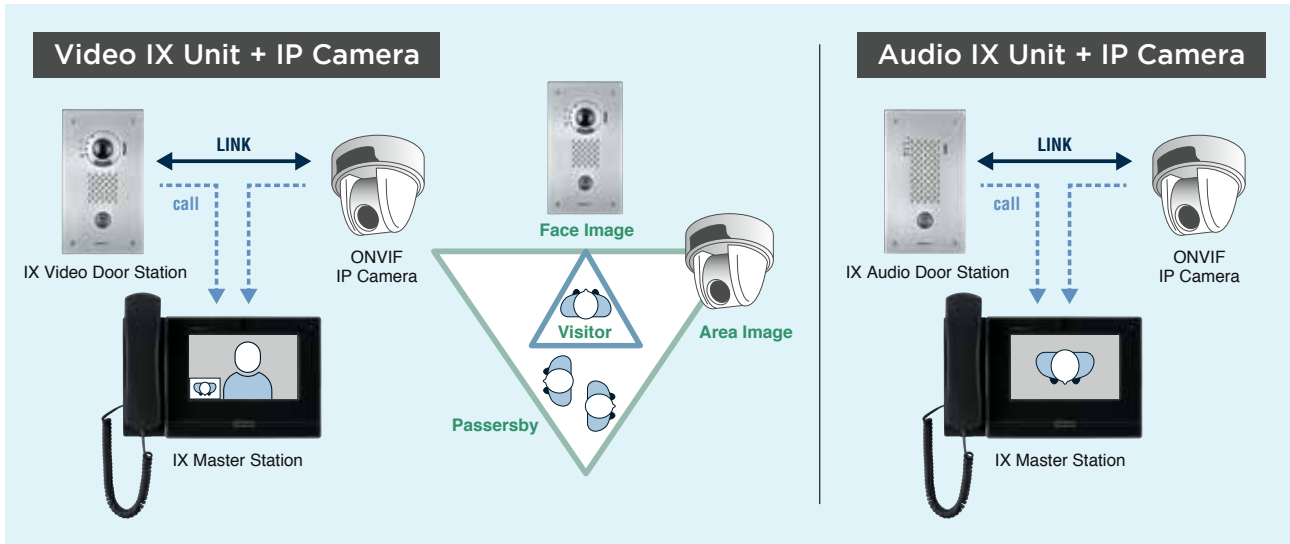

*only for, IX-MV7-HB, IX-MV7-HW, IX-MV7-B and IX-MV7-W

Automatic system status supervision

Two modes of supervision - network connection status and unit function status.

Use the IX master station or your PC to find problems quickly and accurately to provide the utmost communication reliability.*

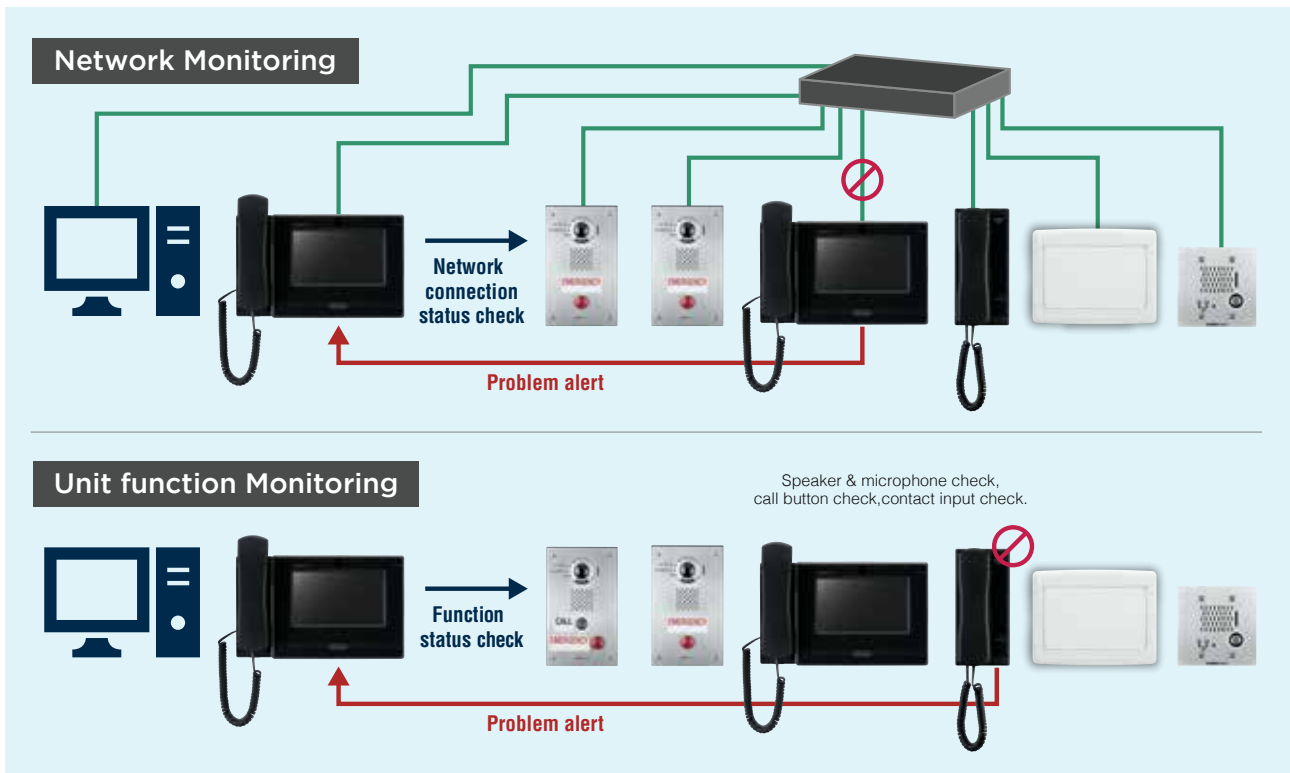

*only for, IX-MV7-HB, IX-MV7-HW, IX-MV7-B and IX-MV7-W

» Examples of Popular Applications

Commercial facilities and offices

All-in-one system for internal communication and emergency assistance.

The new IX enables mutual communication between commercial facilities and offices combining emergency assistance functionality at parking areas, staircases and toilets. All-in-one system configuration also enables support for outside lines.

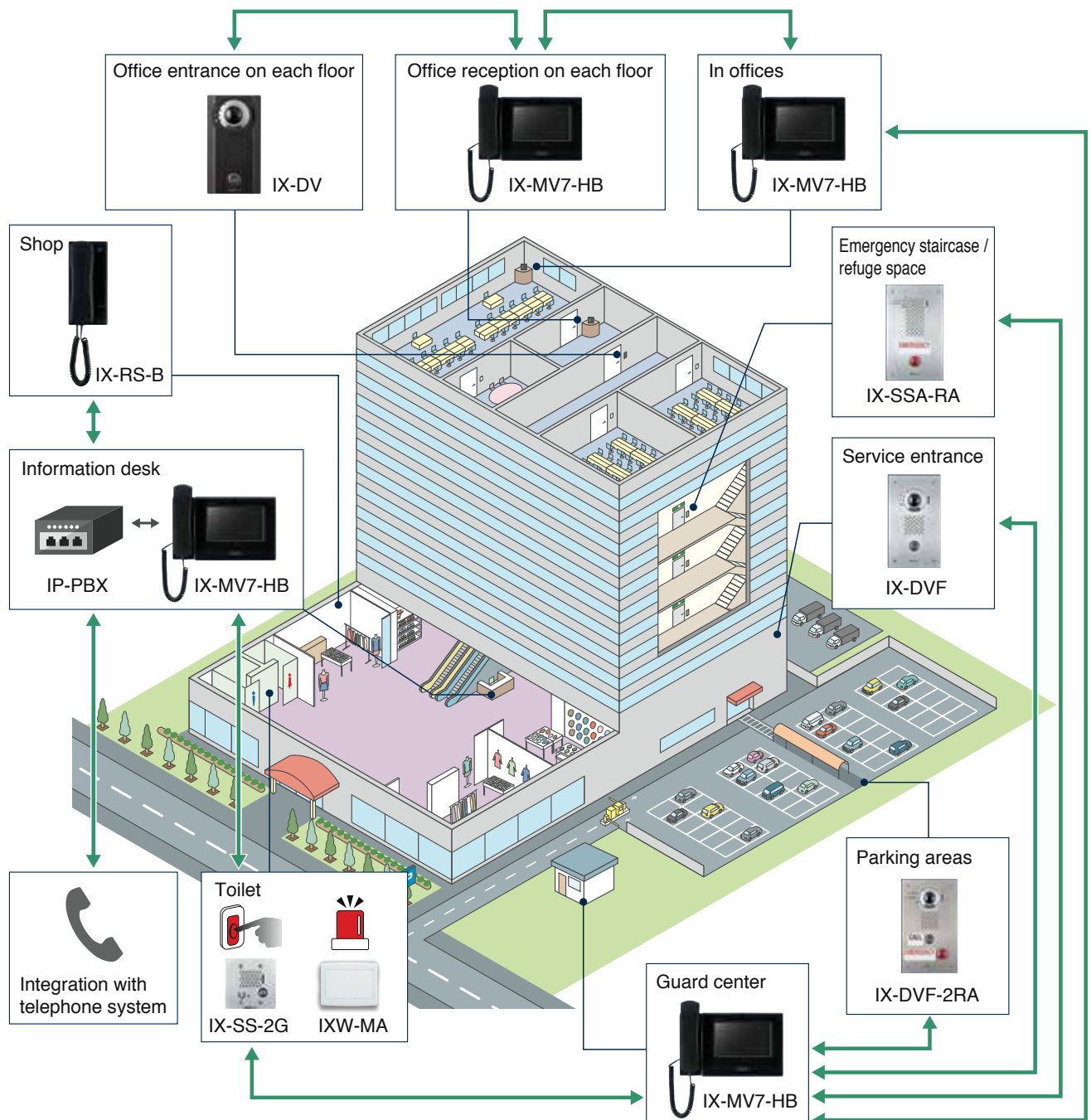

Railways

All-in-one system for help points, communication between remote stations, and video surveillance.

Respond to calls and queries from ticket machines, ticket gates, and platforms with video monitoring. Communication between remote stations is also possible.

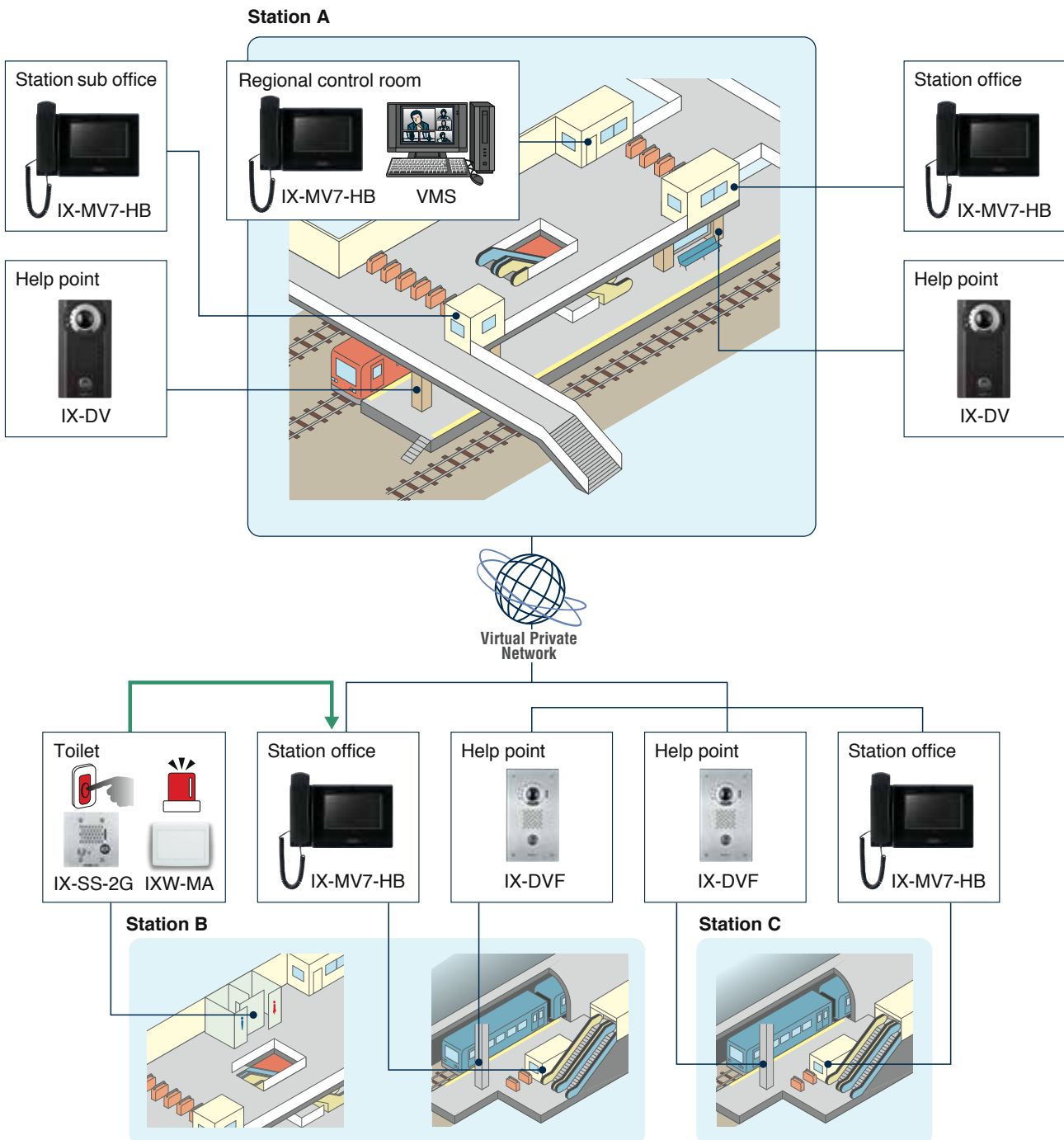

» Examples of Popular Applications

Schools

All-in-one system for door entry management, call transfer for after hours, emergency paging and announcements.

Management of entry and exit points integrated with access control is possible. The system can also be used to enable teachers and staff members to easily communicate with one another. After hours control for schools within the district can be performed at a central control site. Furthermore, use IX for paging and school-wide announcements.

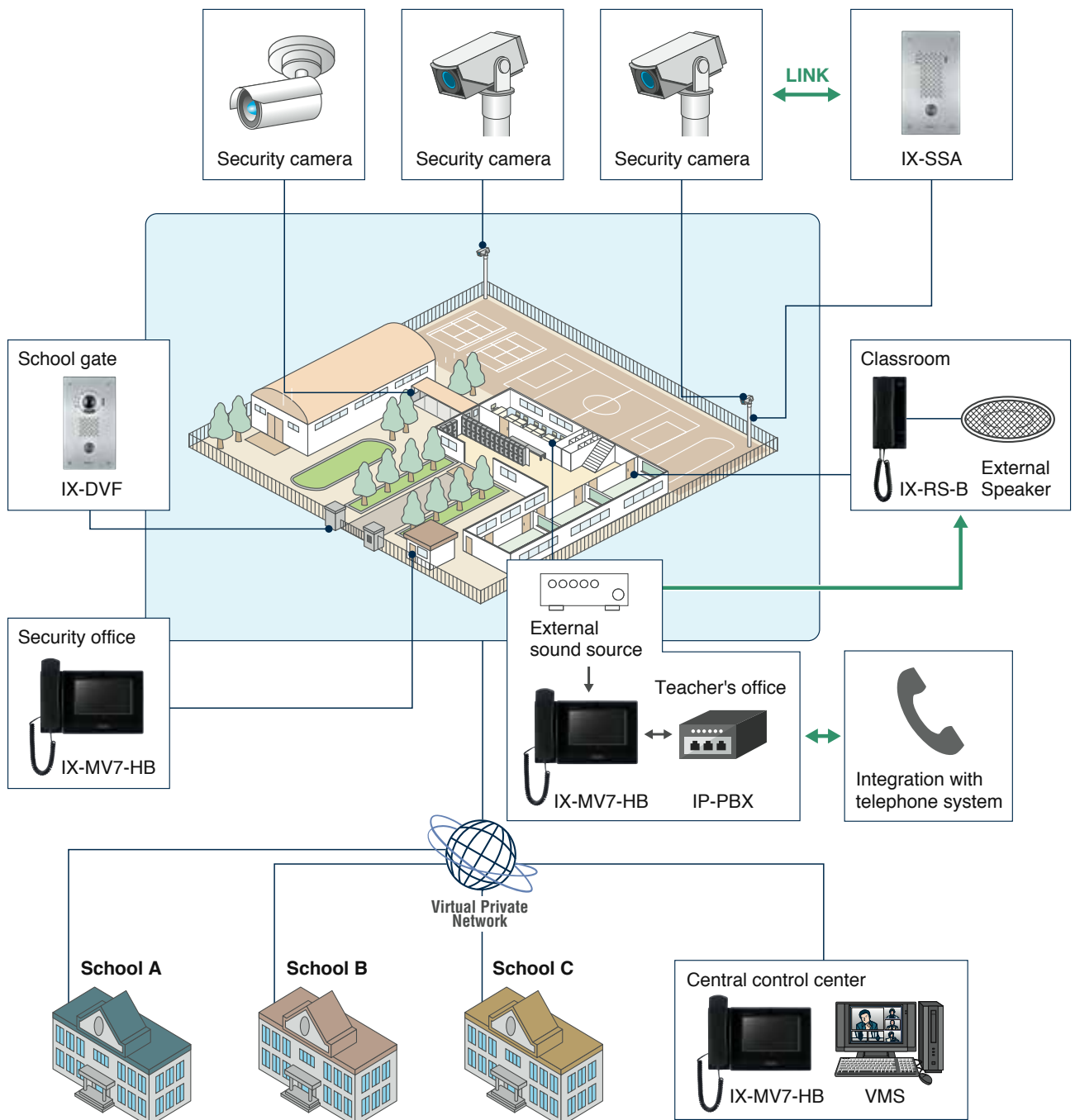

Parking facilities

All-in-one system for emergency calls, remote control of distant parking spaces, and video surveillance.

- Audio communication and video identification allow for immediate response where assistance is needed.
- Crime prevention can be enhanced further through simultaneous installation of network cameras.

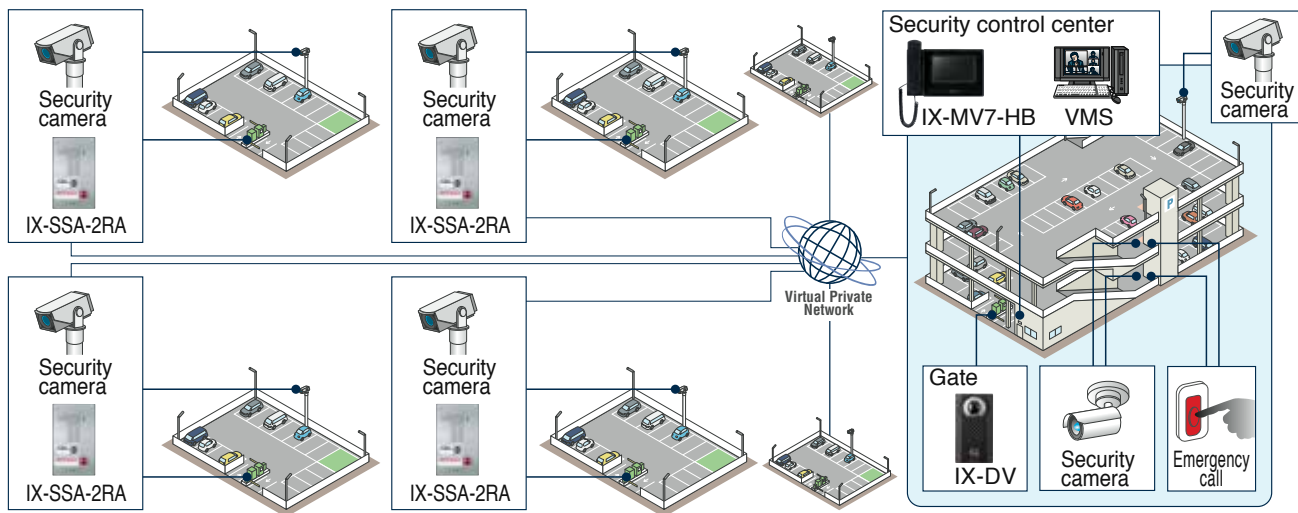

Highway tunnels

Emergency help point system for tunnels and evacuation routes with integrated CCTV functionality.

- Use IX rescue assistance stations to create a communication system for emergency and evacuation purposes.
- Use IX system's unique system status functionality to create a robust and reliable communication network.

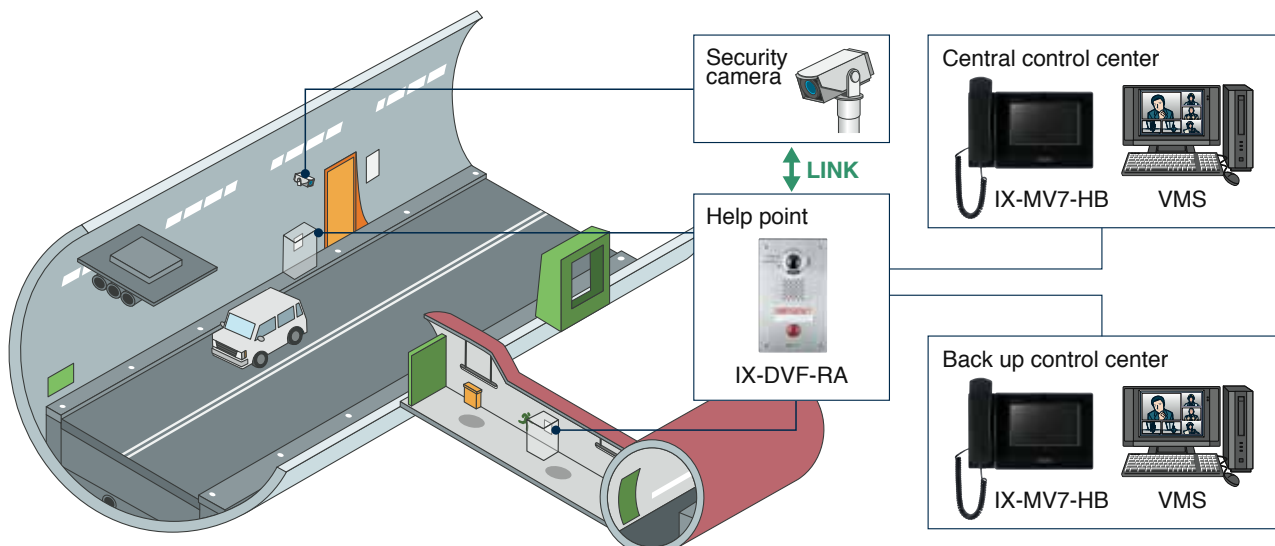

Flexible system configuration to meet your specific application

System Configuration

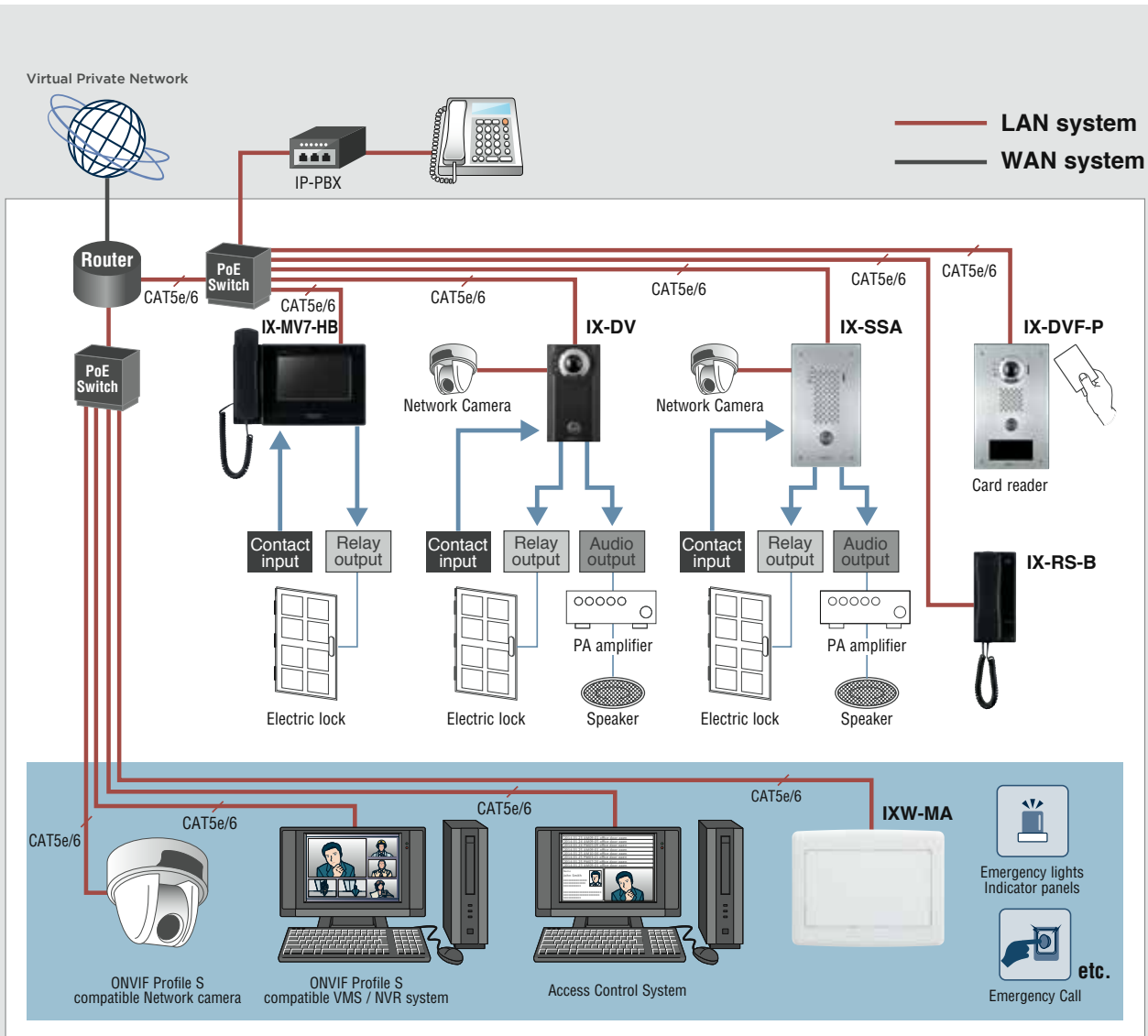

Number of station registrations in address book

Model number	Description	Number of station registrations in address book	
IX-MV7-HB, IX-MV7-HW, IX-MV7-B, IX-MV7-W, IX-MV^{*1}	Master Station	Expanded mode 9999 stations	Standard mode 500 stations
IX-RS-B, IX-RS-W	Handset Sub Station	20 stations ^{*2}	
IX-DV, IX-DVF, IX-DVF-P, IX-DVF-RA, IX-DVF-2RA, IX-DA^{*1}	Video Door Station	20 stations ^{*2}	
IX-SS-2G, IX-SSA, IX-SSA-RA, IX-SSA-2RA, IX-BA^{*1}	Audio Only Door Station	20 stations ^{*2}	

^{*1} IX-MV, IX-DA and IX-BA can not be used in expanded mode.

^{*2} Master stations, sub stations and door stations can be registered (Max 20). IX-DA and IX-BA can only register master stations.

Serverless Configuration Achieves Savings in Space and Installation Work, and Lower Costs

Typical Systems

Typical systems require a "separate server" and the attendant effort of installation work, maintenance and administration. In addition, the server requires a power supply. 

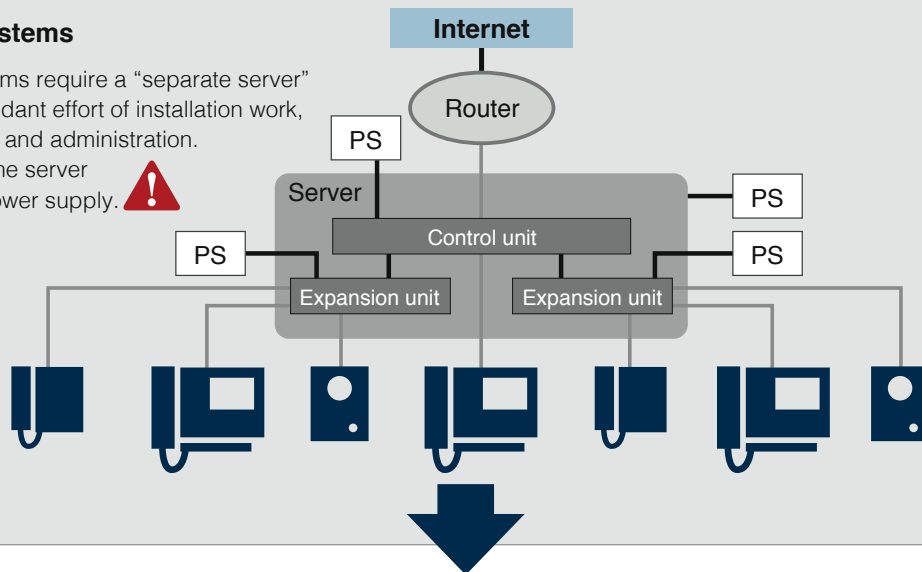

IX System

The IX System is serverless, which eliminates the risk of system downtime due to server malfunction. New IX door stations can be used to connect IP cameras.

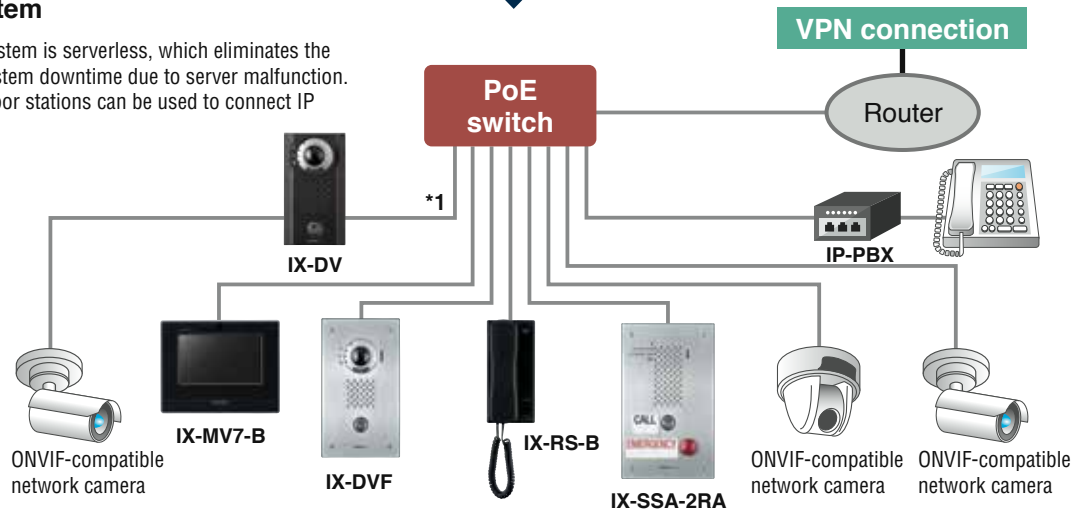

*1 When PoE passthrough function is used, the IX unit must be connected to an IEEE 802.3at compatible PoE switch or hub.

A Guide to Terms

ONVIF (Open Network Video Interface Forum)

The interface specifications established by ONVIF provide standards that enable exchange of live video and audio as well as control information by surveillance cameras and other network video devices, even among products from different manufacturers.

VMS (Video Management System)

This refers to video management software using an IP network. Servers and cameras from any manufacturer can be installed, enabling configuration of systems matched to user needs.

NVR (Network Video Recorder)

This is a device that records video feed from a network camera over an IP network.

API

This refers to a publicly disclosed set of commands and functions that can be used in programming. It enables control of intercom functioning by user programs, and also makes it possible for user programs to acquire information from intercoms.

System Components

Master station



IX-MV7-HB
IP Audio and
Video Master Station
(Black)



IX-MV7-HW
(White)

with Handset

Features

- Directly connectable to an IP network
- 7-inch touch display for easy operation and video monitoring
- Camera with privacy cover
- A variety of display modes designed for different situations
- Hands-free, push-to-talk or handset audio communication
- Direct voice call from master station to another station
- Video image adjusting function
- Record audio and video to a micro SD card at the start of or during a call (SD card not included)
- Play audio or video recordings saved to a micro SD card on a computer
- Call or communication transfer to another master station
- Paging to a group or all stations
- Message paging: Broadcast messages and notifications through the system
- External input paging: Send a page using contact input and external sound input
- Monitor other stations



IX-MV7-B
IP Audio and
Video Master Station
(Black)



IX-MV7-W
(White)

without Handset

Features

- Directly connectable to an IP network
- 7-inch touch display for easy operation and video monitoring
- Camera with privacy cover
- A variety of display modes designed for different situations
- Hands-free, push-to-talk or audio communication
- Direct voice call from master station to another station
- Video image adjusting function
- Record audio and video to a micro SD card at the start of or during a call (SD card not included)
- Play audio or video recordings saved to a micro SD card on a computer
- Call or communication transfer to another master station
- Paging to a group or all stations
- Message paging: Broadcast messages and notifications through the system
- External input paging: Send a page using contact input and external sound input
- Monitor other stations



IX-MV
IP Audio and
Video Master Station

Features

- Directly connectable to an IP network
- 3.5-inch display for operation and video monitoring
- Hands-free, push-to-talk or handset audio communication
- Direct voice call from master station to another station
- Video image adjusting function
- Call or communication transfer to another master station
- Paging to a group or all stations
- Monitor other stations

Handset sub station



IX-RS-B
IP Audio Sub Station
(Black)



IX-RS-W
(White)

Features

- Directly connectable to an IP network
- Calling Group Call: Make an outgoing call to all stations that belong to the selected group.
Contact input call: Make an outgoing call to all stations that belong to the selected contact input call group.
- Calling up to 20 preprogrammed stations simultaneously.
- Receive paging
- Others Door release: Release an electric lock during communication.
Send e-mails: An e-mail can be sent to pre-registered e-mail addresses when triggering events occur.

Specifications

- Power source** Power-over-Ethernet (IEEE 802.3af Class 0)
- Type of communication** Hands-free / Push-to-talk Handset: Full-duplex / Push-to-talk
- Monitor** 7 inch TFT color LCD
- Mounting** Desktop use (with desktop stand) or wall-mount
- Material** Fire-retardant resin
- Input / Output**
 - Contact input ×4
 - Relay output ×2
 - External speaker output (8Ω 0.5w or less) ×1
 - Paging sound source input ×1
 - Voice input / output (3.5mm stereo mini plug) ×1

Unit dimensions

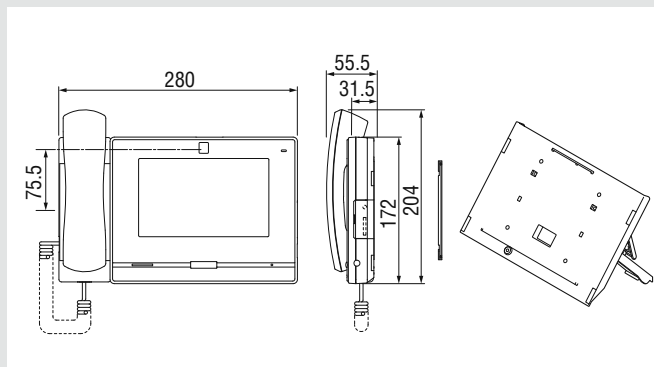

Specifications

- Power source** Power-over-Ethernet (IEEE 802.3af Class 0)
- Type of communication** Hands-free / Push-to-talk
- Monitor** 7 inch TFT color LCD
- Mounting** Desktop use (with desktop stand) or wall-mount
- Material** Fire-retardant resin
- Input / Output**
 - Contact input ×4
 - Relay output ×2
 - External speaker output (8Ω 0.5w or less) ×1
 - Paging sound source input ×1
 - Voice input / output (3.5mm stereo mini plug) ×1

Unit dimensions

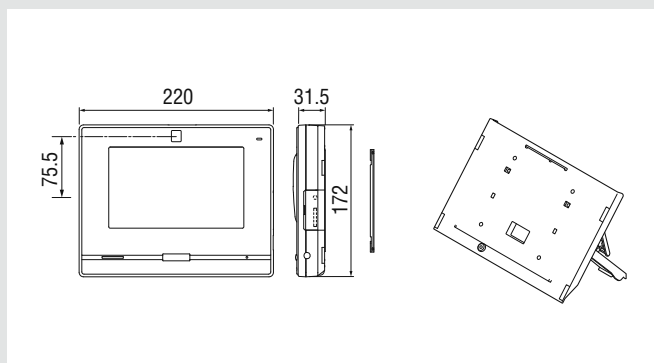

Specifications

- Power source** Power-over-Ethernet (IEEE 802.3af Class 0)
- Type of communication** Hands-free / Push-to-talk Handset: Full-duplex / Push-to-talk
- Monitor** 3.5-inch color LCD monitor
- Mounting** Desktop use (with desktop stand) or wall-mount
- Material** Fire-retardant resin
- Input / Output**
 - Contact input ×1
 - Relay output ×1

Unit dimensions

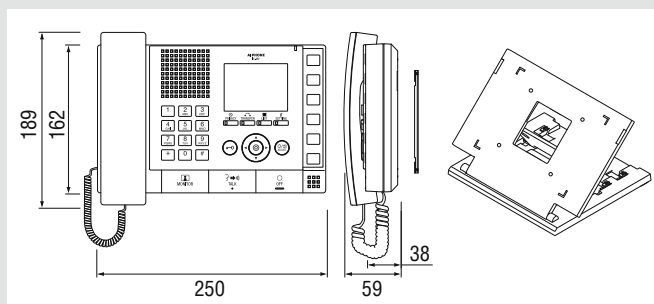

Specifications

- Power source** Power-over-Ethernet (IEEE 802.3af Class 0)
- Type of communication** Handset: Full-duplex Hands-free: Automatic Voice switching
- Mounting** Wall-mount
- Material** Fire-retardant resin
- Input / Output**
 - Contact input ×1
 - Relay output ×1
 - External speaker output (8Ω 2w or less) ×1

Unit dimensions

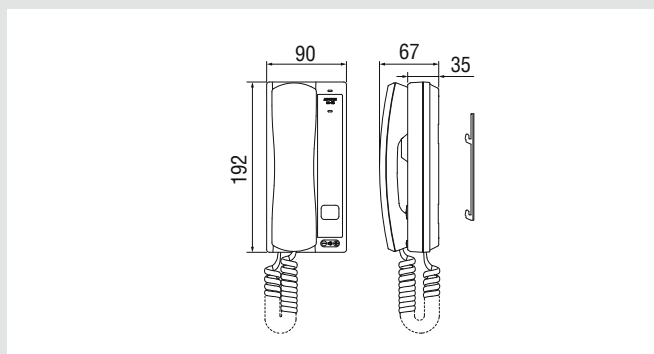

Video door station



IX-DV

- Aluminium
- PoE IEEE802.3af / at
- Wall-mount



IX-DVF

- Stainless steel
- PoE IEEE802.3af / at
- Wall-mount
- Mounting box included



IX-DVF-P

- Stainless steel
 - PoE IEEE802.3af / at
 - Wall-mount
 - Mounting box included
 - Compatible with Non-touch key reader (HID multi CLASS)
- *Non-touch key reader not included

Video door station (Emergency call button and braille models)



IX-DVF-RA

- Stainless steel
- PoE IEEE802.3af / at
- Wall-mount
- Mounting box included
- With Emergency call button and braille (English braille)



IX-DVF-2RA

- Stainless steel
- PoE IEEE802.3af / at
- Wall-mount
- Mounting box included
- With call button and braille (English braille)
- With Emergency call button and braille (English braille)



Audio door station



IX-SSA

- Stainless steel
- PoE IEEE802.3af / at
- Wall-mount
- Mounting box included



IX-SS-2G

- Stainless steel
- PoE IEEE802.3af
- Wall-mount



Audio door station (Emergency call button and braille models)



IX-SSA-RA

- Stainless steel
- PoE IEEE802.3af / at
- Wall-mount
- Mounting box included
- With Emergency call button and braille (English braille)



IX-SSA-2RA

- Stainless steel
- PoE IEEE802.3af / at
- Wall-mount
- Mounting box included
- With call button and braille (English braille)
- With Emergency call button and braille (English braille)



.....Dust and moisture resistant



.....Ruggedized against vandalism



.....STAINLESS STEEL material

Features

- Directly connectable to an IP network
- Door release output
- Status indication for calling, communication and door release.
- Nighttime LED illumination
- Calling up to 20 preprogrammed stations simultaneously
- Calling Group Call: Make an outgoing call to all stations that belong to the selected group.
Contact input call: Make an outgoing call to all stations that belong to the selected contact input call group.
- Call response function (except IX-DVF-RA)
- Record audio and video to a micro SD card (SD card not included)
- Receive paging
- Others Send e-mails
Transmitting video through ONVIF
Schedule-linked message
- Power supply from PoE or external power supply

Specifications

Power source	Power-over-Ethernet (IEEE 802.3af / at Class 0) or PS-2420 / 2420S / UL / BF
Type of communication	Hands-free
Camera	1/3-inch color CMOS
Minimum illumination	5 Lux
Mounting	IX-DV: Wall-mount IX-DVF, IX-DVF-P, IX-DVF-RA, IX-DVF-2RA: Flush wall-mount
Material	Front panel: IX-DV: Die-cast aluminium IX-DVF, IX-DVF-P, IX-DVF-RA, IX-DVF-2RA: Stainless steel
Input / Output (IX-DV, IX-DVF, IX-DVF-P)	• Contact input × 6 • Relay output × 2 • Audio output × 1
Input / Output (IX-DVF-RA, IX-DVF-2RA)	• Contact input × 5 • Relay output × 2 • Audio output × 1

Unit dimensions

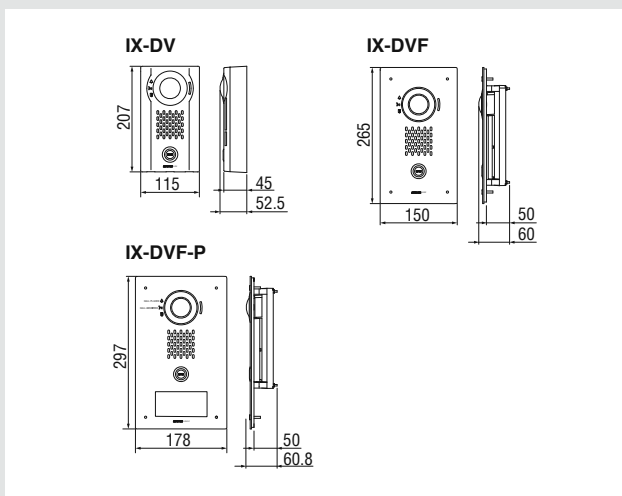

Unit dimensions

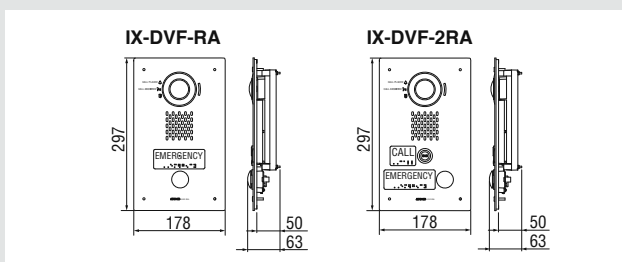

Features

- Directly connectable to an IP network
- Calling up to 20 preprogrammed stations simultaneously.
- Calling Group Call: Make an outgoing call to all stations that belong to the selected group.
Contact input call: Make an outgoing call to all stations that belong to the selected contact input call group.
- Call response function (except IX-SSA-RA)
- Record audio to a micro SD card (except IX-SS-2G, SD card not included)
- Receive paging
- Others Send e-mails / Schedule-linked message
- Power supply from PoE or external power supply (except IX-SS-2G)

Specifications

Power source	Power-over-Ethernet (IEEE 802.3af / at Class 0) or PS-2420 / 2420S / UL / BF (except IX-SS-2G)
Type of communication	Hands-free
Mounting	Flush wall-mount
Material	Front panel: Stainless steel
Input / Output (IX-SSA)	• Contact input × 6 • Relay output × 2 • Audio output × 1
Input / Output (IX-SS-2G)	• Contact input × 1 • Relay output × 1
Input / Output (IX-SSA-RA, IX-SSA-2RA)	• Contact input × 5 • Relay output × 2 • Audio output × 1

Unit dimensions

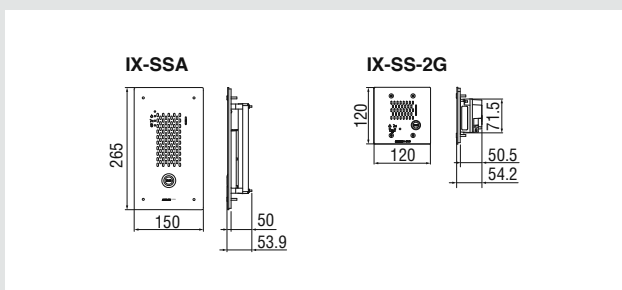

Unit dimensions

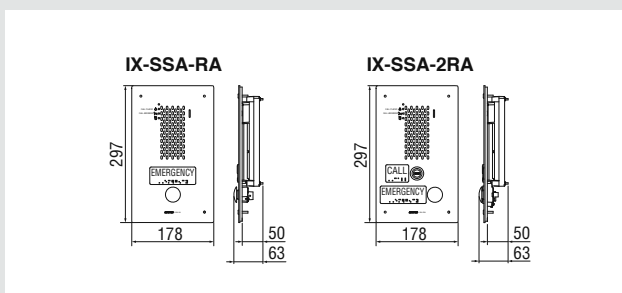

Video door station



IX-DA

IP Audio and Video Door Station

- PoE IEEE 802.3af
- Wall-mount

Features

- Directly connectable to an IP network
- Door release output
- Nighttime LED illumination
- Calling up to 20 preprogrammed master stations simultaneously
- Power supply by PoE

Audio door station



IX-BA

IP Audio Door Station

- PoE IEEE 802.3af
- Wall-mount

Features

- Directly connectable to an IP network
- Door release output
- Nighttime LED illumination
- Calling up to 20 preprogrammed master stations simultaneously
- Power supply by PoE

Multi-purpose adaptor



IXW-MA

Multi-purpose adaptor

Features

- Directly connectable to an IP network
- 4 Contact inputs
- 10 Relay outputs
- Power supply from PoE



.....Dust and moisture resistant



.....Ruggedized against vandalism



.....STAINLESS STEEL material

Specifications

- Power source** Power-over-Ethernet (IEEE 802.3af Class 0)
- Communication** Hands-free, automatic voice switching
- Camera** 1/4-inch color CCD
- Minimum illumination** 5 Lux
- Mounting** Surface-wall mount (directly to wall)
- Material** Front panel: Fire-retardant resin
Main unit: flame resisting resin
- Input/Output**
 - Contact input ×1
 - Relay output ×1
 - Audio output ×1

Unit dimensions

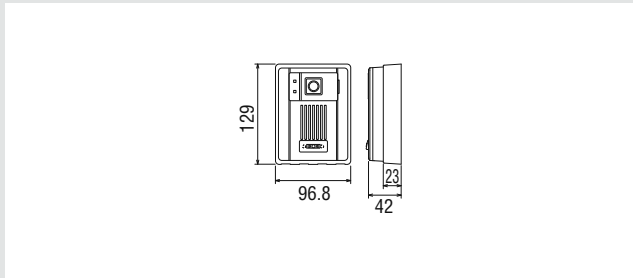

Specifications

- Power source** Power-over-Ethernet (IEEE 802.3af Class 0)
- Communication** Hands-free, automatic voice switching
- Mounting** Surface-wall mount (directly to wall)
- Material** Front panel: Fire-retardant resin
Main unit: flame resisting resin
- Input/Output**
 - Contact input ×1
 - Relay output ×1
 - Audio output ×1

Unit dimensions

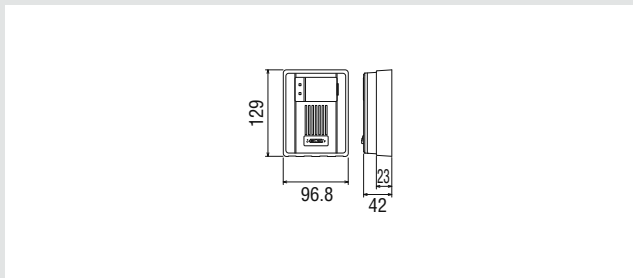

Specifications

- Power source** Power-over-Ethernet (IEEE 802.3af Class 0)
- Mounting** Surface Wall-mount
- Material** Self-extinguishing resin

Unit dimensions

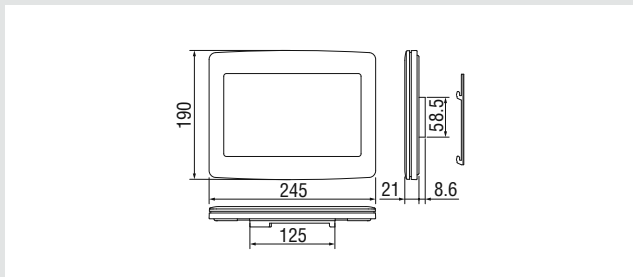

Mobile App



IX Mobile App

Mobile App Sub Master Station for Smartphones and Tablets (mobile devices not included)

- Available on Google Play™
(Google Play is a trademark of Google Inc.)
- Available on the App Store™
(App Store is a service mark of Apple Inc.)
- Provides sub master station functionality with 4 speed dial buttons
- The IX Mobile App requires 1 IX-MV and 1 RY-IP44 per 8 apps in the system



RY-IP44

IP Input/Output Relay Adaptor
(requires PS-1225)

IP Addressable Door Stations



IX-4DF

- PoE
- 4 call buttons for selective calling to IX-MV and IX Mobile (RY-IP44 adaptor required)
- Marine grade stainless steel
- Back box included



IX-PR

- PoE
- Anti-ligature door station meeting Australian Standards to suit prison applications
- Marine grade stainless steel
- Back box optional
(i.e sizing can be met with requirements)

Network Paging Adaptor



IX-PA

IP Addressable Network Paging Adaptor

- 8Ω speaker output
- 600Ω amplifier output
- Audio input
- PoE

Accessories



KAW-D

30° Angle Box for IX-DA or IX-BA



SBX-2G/A

Surface Mount Box for IX-SS-2G

***Use existing 2-wire LE Series or NE Series Audio Door/Sub Stations!**



IX-1AS

2-Wire Audio Door/Sub Station Network Adaptor

- Supports 1 LE Series or NE Series Door/Sub Station



IX-10AS

2-Wire Audio Door/Sub Station Network Adaptor

- Supports up to 10 LE Series or NE Series Door/Sub Stations



SBX-IDVF

Surface Mount Box for IX-DVF, IX-SSA, IX-DF, IX-DF-P, IX-DF-PI or IX-SS



SBX-IDVFRA

Surface Mount Box for IX-DVF-P, IX-DVF-RA, IX-DVF-2RA, IX-SSA-RA, IX-SSA-2RA, IX-DF-2RA, IX-SS-2RA, or IX-SS-RA

Emergency Wall Boxes (optional)



WB-CA*

- Light cage with beacon/strobe light
- "ASSISTANCE" lettering
- Compatible with any IX Series Emergency Station
- Stainless steel
- Wall mount



WB-HA*

- Light hood with beacon/strobe light
- "ASSISTANCE" lettering
- Compatible with any IX Series Emergency Station
- Stainless steel
- Wall mount



WB-CE*

- Light cage with beacon/strobe light
- "EMERGENCY" lettering
- Compatible with any IX Series Emergency Station
- Stainless steel
- Wall mount



WB-HE*

- Light hood with beacon/strobe light
- "EMERGENCY" lettering
- Compatible with any IX Series Emergency Station
- Stainless steel
- Wall mount



Emergency Towers

Please contact Aiphone for more details.



PS-2420

24V DC, 2A Power Supply

*Power supply required for beacon/strobe light with Wall Box

Distributed by :

Deming Prize



Deming Medal

ISO 9001



JQA-0291
Corresponding product
Standard product
Order product
AIPHONE CO.,LTD.

ISO 14001



JQA-EM0453
HEADQUARTERS
TOYOTA FACTORY
TAIHOH SITE
DEVELOPMENT CENTER
AIPHONE CO.,LTD.

AIPHONE®
Providing Peace of Mind

AIPHONE PTY LTD
Unit 11A, 2 Eden Park Drive
Macquarie Park, NSW 2113
Australia
Tel.: +61 2-8036-4507
URL: aiphone.com.au

IX(E)1802A

All rights reserved. All statements valid at time of printing. The design and specifications are subject to change without notice for improvement.

Printed in Australia (E)
QB60099AHZ